

КЛЕММНЫЕ БЛОКИ > КЛЕММНЫЕ КОЛОДКИ С ВСТАВНЫМ КРЕПЛЕНИЕМ > ПРЕДОХРАНИТЕЛЬНЫЕ КЛЕММЫ

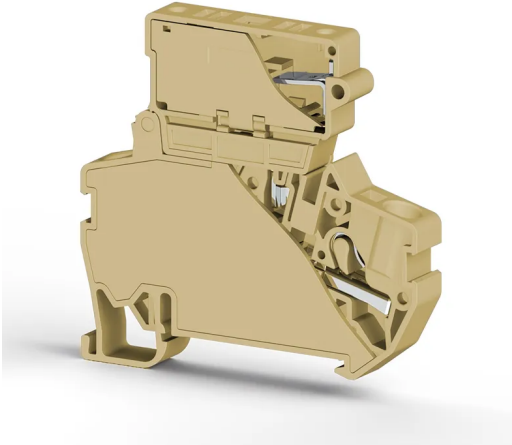

РҮК 4SLD 24VDC 5x25 Бежевый

Артикул (SKU): 307290

4 мм² Push-In клемма с предохранителем (LED 24VDC) (5x20)

Коммерческая информация

Код продажи продукта	307290
Единица Упаковки	15 шт.
Номер таможенного тарифа	853690950000
Вес за единицу, включая упаковку	0.02213333 kg.

Техническая информация

PRODUCT FEATURES	
Number of Connections	2
Color	Beige
Number of Levels	1
Insulation Material	PA
UL 94 Flammability Class	V2
Impulse Voltage Category	III
Insulation Material Group	I
Pollution Degree	3
Connection According to Standard	IEC 60947-7-3
Continuous Operating Temperature max.	120 °C
Continuous Operating Temperature min.	-55 °C

Fuse	G/5X25
Fuse Type	Glass

ELECTRICAL FEATURES

Nominal Impulse Voltage	6 Kv
Nominal Voltage	24 V
Nominal Current In Fuse	10 A

CONNECTION DATA

Connection Type	Push-In Connection
Single-core min. conductor cross-section	0,34 mm²
Single-core max. conductor cross-section	6 mm²
Conductor Cross Section Awgkcmil Min	22 AWG
Conductor Cross Section Awgkcmil Max	10 AWG
Multi-core min. conductor cross-section	0,25 mm²
Multi-core max. conductor cross-section	4 mm²
Multi-core min. conductor cross-section with ferrule	0,34 mm²
Multi-core max. conductor cross-section with ferrule	4 mm²
Min. Stripping Length	9 mm
Max. Stripping Length	10 mm
Internal cylindrical indicator	A4
2 Conductors Of The Same Cross Section Multi Core Twin Ferrule With Plastic Sleeve	1 mm²

DIMENSIONS

Width	8 mm
Length	63,10 mm
Height Mr 35X75	61,10 mm
Height MR 35x15	68,60 mm