

TERMINAL BLOCKS > PUSH-IN TYPE TERMINAL BLOCKS > FUSE TERMINALS

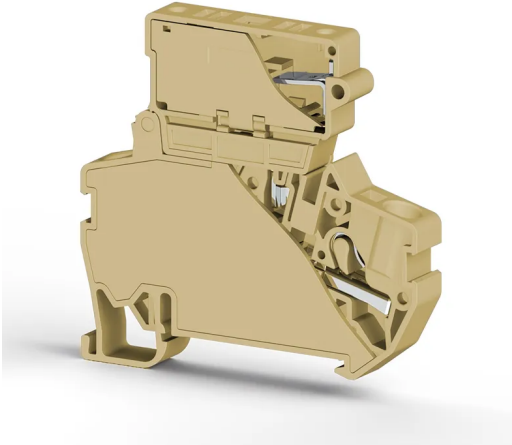

PYK 4SLD 220VAC 5x25 Bej

Stock Keeping Unit (SKU): 307300

4 mm² Push-In Fuse Terminal Block (LED 24VDC) (5×20)

Commercial Information

Product Sales Code	307300
Package Unit	15 pcs.
Customs Tariff Number	853690950000
Weight Per Unit Including Packaging	0.02213333 kg.

Technical Information

PRODUCT FEATURES	
Number of Connections	2
Color	Beige
Number of Levels	1
Insulation Material	PA
UL 94 Flammability Class	V2
Impulse Voltage Category	III
Insulation Material Group	I
Pollution Degree	3
Connection According to Standard	IEC 60947-7-3
Continuous Operating Temperature max.	120 °C
Continuous Operating Temperature min.	-55 °C

Fuse	G/5X25
Fuse Type	Glass

ELECTRICAL FEATURES

Nominal Impulse Voltage	6 Kv
Nominal Voltage	220 V
Nominal Current In Fuse	10 A

CONNECTION DATA

Connection Type	Push-In Connection
Single-core min. conductor cross-section	0,34 mm²
Single-core max. conductor cross-section	6 mm²
Conductor Cross Section Awgkcmil Min	22 AWG
Conductor Cross Section Awgkcmil Max	10 AWG
Multi-core min. conductor cross-section	0,25 mm²
Multi-core max. conductor cross-section	4 mm²
Multi-core min. conductor cross-section with ferrule	0,34 mm²
Multi-core max. conductor cross-section with ferrule	4 mm²
Min. Stripping Length	9 mm
Max. Stripping Length	10 mm
Internal cylindrical indicator	A4
2 Conductors Of The Same Cross Section Multi Core Twin Ferrule With Plastic Sleeve	1 mm²

DIMENSIONS

Width	8 mm
Length	63,10 mm
Height Mr 35X75	61,10 mm
Height MR 35x15	68,60 mm