

TERMINAL BLOCKS > SPRING CLAMP TYPE TERMINAL BLOCKS > ELECTRONICS
COMPONENT TERMINALS

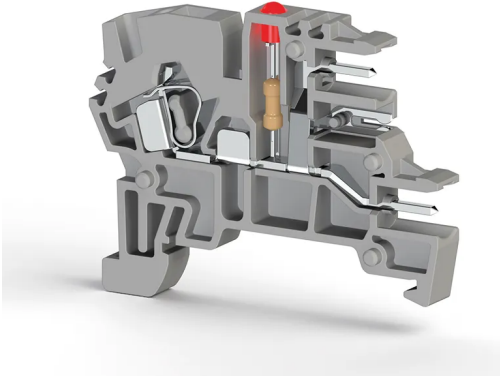

PCY 2,5EL 220V DC Grey

Stock Keeping Unit (SKU): 364075

2.5mm² Cage Clamp 3-Pole PCB Socket Terminal Block

Commercial Information

Product Sales Code	364075
Package Unit	50 pcs.
Customs Tariff Number	853690950000
Weight Per Unit Including Packaging	0.0059 kg.

Technical Information

PRODUCT FEATURES	
Number of Connections	3
Color	Grey
Number of Levels	1
Insulation Material	PA
UL 94 Flammability Class	V2
Impulse Voltage Category	3
Insulation Material Group	1
Pollution Degree	3
Connection According to Standard	IEC 60947-7-1
Continuous Operating Temperature max.	120 °C
Continuous Operating Temperature min.	-55 °C

ELECTRICAL FEATURES

Nominal Impulse Voltage	4 Kv
Nominal Current	10 A
Nominal Voltage	220 V
Maximum Load Current	10 A

CONNECTION DATA

Connection Type	Spring Connection
Single-core min. conductor cross-section	0,,08 mm²
Single-core max. conductor cross-section	4 mm²
Conductor Cross Section Awgkcmil Min	28 AWG
Conductor Cross Section Awgkcmil Max	12 AWG
Multi-core min. conductor cross-section	0,08 mm²
Multi-core max. conductor cross-section	2,5 mm²
Multi-core min. conductor cross-section with ferrule	0,14 mm²
Multi-core max. conductor cross-section with ferrule	2,5 mm²
Min. Stripping Length	9 mm
Max. Stripping Length	10 mm
Internal cylindrical indicator	A3
2 Conductors Of The Same Cross Section Multi Core Twin Ferrule With Plastic Sleeve	0,5 mm²

DIMENSIONS

Width	5,05 mm
Length	47,40 mm
Height Mr 35X75	37,20 mm
Height MR 35x15	44,70 mm