

KLEA

4 Quadrant
Energy Analyzer

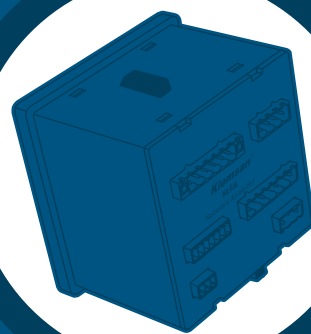

**User
Manual**

Klemsan[®]

TABLE OF CONTENTS

SECTION 1	GENERAL INFORMATION	8
1.1	Symbols.....	9
1.2	General Warnings	9
1.3	Receipt Control and Contents of Delivery	9
1.4	KLEA Energy Analyzer	10
1.5	KleaCom Software.....	11
1.6	KLEA Front Panel.....	12
1.7	Four-Quadrant Representation	13
SECTION 2	INSTALLATION	14
2.1	Preparing for Installation	15
2.2	MOUNTING	15
2.3	Wiring Diagrams	18
2.3.1	Three Phase Connection With Neutral (3P4W)	18
2.3.2	Three Phase Connection No Neutral (3P3W)	19
2.3.3	Three Phase No Neutral Aron Connection	19
2.3.4	Digital Output Connection Diagram	20
2.4	Dimensions.....	20
SECTION 3	MENUS	21
3.1	“First Power-on” Settings.....	22
3.1.1	Dil / Language	22
3.1.2	Date	23
3.1.3	Time.....	24
3.1.4	Current Transformer Ratio (CTR)	24
3.1.5	Voltage Transformer Ratio (VTR).....	25
3.1.6	Connection	26
3.1.7	Start.....	27
3.2	Startup Screen	27
3.2.1	Settings	28
3.2.1.1	Setup Menu	28
3.2.1.1.1	Network Menu.....	29
3.2.1.1.1.1	Current Transformer Ratio.....	30
3.2.1.1.1.2	Voltage Transformer Ratio.....	30
3.2.1.1.1.3	Connection	31
3.2.1.1.1.4	Demand Period	31
3.2.1.1.1.5	Power Unit	32
3.2.1.1.2	Device Menu	32
3.2.1.1.2.1	Language.....	33
3.2.1.1.2.2	Contrast.....	33
3.2.1.1.2.3	Password Protection and New Password.....	34
3.2.1.1.2.4	Display on Selection.....	34
3.2.1.1.2.5	Display on Time	35
3.2.1.1.3	Energy Menu	35
3.2.1.1.3.1	T1_1 start time.....	35
3.2.1.1.3.2	T1_2 start time.....	36
3.2.1.1.3.3	T1_3 start time.....	37
3.2.1.1.3.4	Start of day.....	38

3.2.1.1.3.5	Start of month	38
3.2.1.1.3.6	T1 kWh.....	38
3.2.1.1.3.7	T1 kWh E.	38
3.2.1.1.3.8	T1 kWh Imp. I.	38
3.2.1.1.3.9	T1 kWh Imp. C.	38
3.2.1.1.3.10	T1 kVArh Exp. I.	38
3.2.1.1.3.11	T1 kVArh Exp. C.....	38
3.2.1.1.3.12	T2 kWh	39
3.2.1.1.3.13	T2 kWh E.	39
3.2.1.1.3.14	T2 kVArh Imp. I.	39
3.2.1.1.3.15	T2 kVArh Imp. C.....	39
3.2.1.1.3.16	T2 kVArh Exp. I.	39
3.2.1.1.3.17	T2 kVArh Exp. C.	39
3.2.1.1.4	Digital Input Menu.....	40
3.2.1.1.4.1	Input1 Menu.....	41
3.2.1.1.4.1.1	Mode	41
3.2.1.1.4.1.2	Delay	42
3.2.1.1.4.2	Input 2 Menu.....	42
3.2.1.1.4.3	Input 3 Menu (optional).....	43
3.2.1.1.4.4	Input 4 Menu (optional).....	43
3.2.1.1.4.5	Input 5 Menu (optional).....	43
3.2.1.1.4.6	Input 6 Menu (optional).....	43
3.2.1.1.4.7	Input 7 Menu (optional).....	43
3.2.1.1.5	Digital Output Menu	43
3.2.1.1.5.1	Output1 Menu	44
3.2.1.1.5.2	Output2 Menu	46
3.2.1.1.5.3	Output3 Menu (optional)	46
3.2.1.1.5.4	Output4 Menu (optional)	46
3.2.1.1.5.5	Output5 Menu (optional)	46
3.2.1.1.5.6	Output6 Menu (optional)	46
3.2.1.1.5.7	Output7 Menu (optional)	46
3.2.1.1.6	Analog Output Menu (Optional).....	47
3.2.1.1.6.1	Output1 Menu	47
3.2.1.1.6.1.1	Input mode	48
3.2.1.1.6.1.2	Output connection	49
3.2.1.1.6.1.3	Min. value	50
3.2.1.1.6.1.4	Max. value	50
3.2.1.1.6.1.5	Multiplier	50
3.2.1.1.6.2	Output2 Menu	53
3.2.1.1.6.3	Output3 Menu	53
3.2.1.1.6.4	Output4 Menu	53
3.2.1.1.7	Communication Menu.....	53
3.2.1.1.7.1	Baud Rate Menu.....	54
3.2.1.1.7.2	Slave Id	54
3.2.1.1.8	Alarm Menu.....	54
3.2.1.1.8.1	V(L-N) Menu.....	55
3.2.1.1.8.2	V(L-L) Menu.....	57
3.2.1.1.8.3	Current Menu.....	57
3.2.1.1.8.4	P Menu	57

3.2.1.1.8.5	Q Menu.....	57
3.2.1.1.8.6	S Menu.....	57
3.2.1.1.8.7	CosØ Menu	57
3.2.1.1.8.8	PF Menu	58
3.2.1.1.8.9	IN Menu.....	58
3.2.1.1.8.10	F Menu.....	58
3.2.1.1.8.11	Temp. Menu.....	58
3.2.1.1.8.12	Harmonics V Menu	59
3.2.1.1.8.13	Harmonics I Menu	60
3.2.1.1.9	Clear Menu.....	60
3.2.1.2	Date / Time Menu	62
3.2.1.3	System Info Menu.....	62
3.2.1.4	Password Menu	63
3.2.1.5	Restart Menu.....	63
3.2.1.6	Default Settings	64
3.2.2	Measure Menu.....	64
3.2.2.1	Instantaneous Menu	65
3.2.2.2	Demand Menu	66
3.2.2.2.1	Current Month Menu	67
3.2.2.2.1.1	Current Menu.....	68
3.2.2.2.1.2	Active power menu	69
3.2.2.2.1.3	Reactive power menu.....	69
3.2.2.2.1.4	Apparent power menu	69
3.2.2.2.2	1 month Ago Menu.....	69
3.2.2.2.3	2 Months Ago Menu.....	70
3.2.2.2.4	3 Months Ago Menu.....	70
3.2.2.3	Phasor Diagram Menu	70
3.2.2.4	Signals Menu.....	70
3.2.2.5	Harmonics Menu	71
3.2.2.5.1	Table Menu	71
3.2.2.5.2	Graph Menu.....	72
3.2.3	Meters Menu	72
3.2.3.1	Imp. Active Menu.....	72
3.2.3.1.1	T1 Tab.....	73
3.2.3.1.2	T1 Rate1 Tab.	73
3.2.3.1.3	T1 Rate2 Tab.	74
3.2.3.1.4	T1 Rate3 Tab.	74
3.2.3.1.5	T2 Tab.....	75
3.2.3.2	Digital Input Menu.....	76
3.2.3.3	Others Menu	76
3.2.4	Alarms Menu	76
3.2.4.1	Phase1 Menu.....	78
3.2.4.2	Phase2 Menu.....	79
3.2.4.3	Phase3 Menu.....	79
3.2.4.4	Other Menu	79
3.2.5	Analysis Menu.....	79
3.2.5.1.1	Hourly Menu.....	80
3.2.5.1.1.1	Phase1 Menu.....	81
3.2.5.1.1.2	Phase2 Menu.....	81

3.2.5.1.1.3	Phase3 Menu.....	81
3.2.5.1.1.4	Other	81
3.2.5.1.2	Daily Menu.....	81
3.2.5.1.3	Monthly Menu	81
3.2.5.2	Maximum Menu.....	81
3.2.5.3	Average Menu	81

SECTION 4 MODBUS PROTOCOL.....82

4.1	RS485 Wiring Diagram	83
4.2	Computer Connection	83
4.3	Message Format and Data Types of MODBUS-RTU Protocol	83
4.4	Implemented functions for MODBUS-RTU Protocol.....	84
4.5	Data and Setting Parameters for KLEA	84
4.5.1	Measured and Calculated Data	84
4.5.1.1	Alarm Flags	102
4.5.1.2	Digital Input Flags	103
4.5.2	KLEA Setting Parameters	105
4.5.3	ARCHIVE (HISTORY) RECORDS	112
4.5.3.1	Hourly archive data	114
4.5.3.2	Daily archive data	116
4.5.3.3	Monthly archive data	117
4.5.4	Clear	117

SECTION 5 FACTORY DEFAULT SETTINGS..... 119

SECTION 6 TECHNICAL SPECIFICATIONS..... 123

FIGURES

Figure 1-1	KLEA Display.....	12
Figure 1-2	Four-Quadrant Representation	13
Figure 2-1	Mounting KLEA into the Panel	16
Figure 2-2	Fixing KLEA to the panel.....	16
Figure 2-3	Loosening of Terminal Block Screws.....	16
Figure 2-4	Inserting Cable into the Terminal Block	17
Figure 2-5	Fixing the Cable to the Terminal Block	17
Figure 2-6	KLEA Star (WYE) Connection Diagram.....	18
Figure 2-7	KLEA 3 Phase Delta Connection Diagram.....	19
Figure 2-8	KLEA Aron Connection Diagram.....	19
Figure 2-9	Digital Output Connection Diagram	20
Figure 2-10	Dimensions	20
Figure 3-1	First Power-on Settings	22
Figure 3-2	Dil / Language	22
Figure 3-3	Date	23
Figure 3-4	Example for Setting the Date	23
Figure 3-5	Current Transformer Ratio	24
Figure 3-6	Entering Values to the Virtual Keyboard	25
Figure 3-7	Voltage Transformer Ratio.....	26
Figure 3-8	Connection Types.....	26
Figure 3-9	Start	27
Figure 3-10	Startup Screen	27

Figure 3-11	Settings Menu.....	28
Figure 3-12	KLEA Save Query.....	29
Figure 3-13	Network Menu.....	29
Figure 3-14	Setting Current Transformer Ratio	30
Figure 3-15	Setting Voltage Transformer Ratio	30
Figure 3-16	Connection	31
Figure 3-17	Demand Period	31
Figure 3-18	Power Unit Setup.....	32
Figure 3-19	Device Menu	32
Figure 3-20	Language Selection.....	33
Figure 3-21	Options for Contrast	33
Figure 3-22	Entering New Password	34
Figure 3-23	Setting Display on Time	34
Figure 3-24	Energy Menu	35
Figure 3-25	T1_1 start time.....	36
Figure 3-26	T1_2 start time.....	36
Figure 3-27	T1_3 start time	37
Figure 3-28	Digital Input Menu.....	40
Figure 3-29	Digital Input Menu (With IO option)	40
Figure 3-30	Mode Selection	41
Figure 3-31	Digital Input1 Counter.....	41
Figure 3-32	Delay	42
Figure 3-33	Tariff 1 or Tariff 2 ctivation	42
Figure 3-34	Digital Output Menu	43
Figure 3-35	Digital Output Menu (optional digital I/O model).....	44
Figure 3-36	Output1 Menu.....	45
Figure 3-37	Analog Output Menu	47
Figure 3-38	Output1	48
Figure 3-39	Input mode.....	49
Figure 3-40	Output connection	49
Figure 3-41	Vout1 -> ON ; lout1 -> OFF	49
Figure 3-42	Vout1 -> OFF; lout1 -> ON.....	50
Figure 3-43	Multiplier	51
Figure 3-44	Communication Menu.....	53
Figure 3-45	Setting Baud Rate	54
Figure 3-46	Slave Id	54
Figure 3-47	Alarm Menu.....	54
Figure 3-48	V(L-N) Menu.....	55
Figure 3-49	Alarm Relay Setup	55
Figure 3-50	Alarm Time Setting	56
Figure 3-51	Hysteresis Setting	56
Figure 3-52	Alarm Example	57
Figure 3-53	Setting for No Alarm.....	58
Figure 3-54	Invalid Limits message	59
Figure 3-55	Harmonics Menu	59
Figure 3-56	THDV High Limit Setting.....	60
Figure 3-57	V3 - V21 Harmonic High Limit	60
Figure 3-58	Clear Menu.....	60
Figure 3-59	Before Clear	61

Figure 3-60	After Clear	61
Figure 3-61	Initial Value, After Clear Process	62
Figure 3-62	Date / Time Menu	62
Figure 3-63	System Info	63
Figure 3-64	Password.....	63
Figure 3-65	Restart.....	64
Figure 3-66	Default Settings Command	64
Figure 3-67	Measure Menu	65
Figure 3-68	Instantaneous Menu	65
Figure 3-69	Connecting the K-L ends of Current Correctly	66
Figure 3-70	Demand Menu.....	66
Figure 3-71	Demand Example	67
Figure 3-72	Current Month Menu	67
Figure 3-73	Example of Current Month Menu	68
Figure 3-74	Current Menu	68
Figure 3-75	Phasor Diagram Menu	70
Figure 3-76	Signals Menu.....	71
Figure 3-77	Harmonics Menu	71
Figure 3-78	Harmonics in Table Format	71
Figure 3-79	Harmonics in Graphical Format.....	72
Figure 3-80	Imp. Active Menu.....	73
Figure 3-81	Imp. Active Energy Page	73
Figure 3-82	T1 rate1 import active energy	74
Figure 3-83	T1 rate2 import active energy	74
Figure 3-84	T1 rate3 import active energy.....	75
Figure 3-85	Tariff 2 impo t active energy	75
Figure 3-86	Digital Input Menu(Dijital IO opsiyonlu model)	76
Figure 3-87	Alarms Menu	78
Figure 3-88	Phase1 Menu.....	78
Figure 3-89	Other Menu	79
Figure 3-90	Analysis Menu.....	80
Figure 3-91	Minimum Menu	80
Figure 3-92	Hourly Menu.....	80
Figure 4-1	RS485 Wiring Diagram.....	83
Figure 4-2	Connection of KLEA to a PC.....	83

TABLES

Table 4-1	Message Format.....	83
Table 4-2	int (32 bit) data type	84
Table 4-3	Implemented functions for MODBUS RTU Protocol	84
Table 4-4	Read-only Data.....	85
Table 4-5	Setting Parameters.....	105
Table 4-6	Description List	111
Table 4-7	Archive (History) Record Table.....	113
Table 4-8	Clear Address Table.....	118



**SECTION 1
GENERAL
INFORMATION**



BÖLÜM 1 GENERAL INFORMATION

1.1 Symbols



Caution:

Wherever used, this symbol indicates that there is important information that must be taken into consideration.



Danger of Electric Shock:

This symbol indicates that there is dangerous voltage or current.

1.2 General Warnings

- Do not work under live supply conditions. Before installation, turn off the power of the panel or any other related equipment.
- Installation, operation and commissioning (putting into service) of KLEA must be performed by qualified personnel.
- The device must be put into service only after all connections are made.
- KLEA is connected to current transformer(s). Before disconnecting current transformer leads, be sure that they are short circuited elsewhere or connected to a parallel load which has sufficiently low impedance. Otherwise dangerously high voltages will be induced at the current transformer leads. Same phenomena also apply for putting into service.
- Keep and store away from moisture, dust, vibration and wet environment.
- For cleaning, remove the dust with a dry cloth. Do not use abrasives, solvents or alcohol.
- There are no user serviceable parts inside. Maintenance and calibration can only be carried out at manufacturer's end.
- It is recommend to connect circuit breakers or automatic fuses between voltage inputs of Klea and the network.

1.3 Receipt Control and Contents of Delivery

When you receive the package, please be sure that,

- packing is in good condition,
- product has not been damaged during transportation,
- product name and reference (order) number conforms to your order.

KLEA Order Number:	Description:
606130	Klea 320P-D base model
606131	Klea 320P-D optional digital IO model
606132	Klea 320P-D optional 2 analog outputs model
606133	Klea 320P-D optional 4 analog outputs model

Please also check the contents of delivery as listed below:

- 1 pc. KLEA
- 1 pc., CD-ROM (User manual and KleaCom software)
- 2 pcs., fixing brackets and screws
- 1 pc., 4-pin female terminal block for alarm outputs (NO, C/out2, C/out1, NO)
- 1 pc., 6-pin female terminal block for current inputs (I1 , k1 , I2 , k2 , I3 , k3)
- 1 pc., 3-pin female terminal block for supply input (Un)
- 1 pc., 3-pin terminal block for digital inputs (DI1, GND, DI2)
- 1 pc., 4-pin female terminal block for voltage inputs (L1 , L2 , L3 , N)
- 1 pc., 7-pin female terminal block for digital output and RS485 (B, GND1, A, DO1+, DO1-, DO2+, DO2-)
- 2 pcs., 10-pin female terminal block for digital IO optional (KLEA - 606101) product (DO3+, DO3- ...), (DI3, GND3...)
- 1 pc., 4-pin female terminal block for two analog output optional (KLEA - 606102) product (AO1-GND, AO2-GND)
- 1 pc., 8-pin female terminal block for four analog output optional (KLEA - 606103) product (AO1-GND, ..., AO4-GND)

1.4 KLEA Energy Analyzer

KLEA is a multi functional energy analyzer. KLEA,

Measures/calculates:

- Current, voltage and frequency
- Active, reactive and apparent power
- Current and voltage harmonics up to 51. harmonic
- THDV, THDI
- Power factor, $\cos\phi$ for each phase.

KLEA has " Import Active", " Export Active", "Reactive R1", "Reactive R2", "Reactive R3", "Reactive R4" meters. These meters record "1st tariff ", "T1_1", "T1_2" and "T1_3" energy values.

- There is an isolated RS485 port in KLEA.
- KLEA's energy/meter values can be assigned to digital outputs.
- It has 2 pieces of relay outputs.

Besides, KLEA has numerous features such as;

- Setting alarms for various measurement parameters,
- Monitoring official energy meters by means of assigning initial values for Klea tariff meters,
- Compatibility for 3 phase/3 wire, 3 phase/4wire or aron connected systems,
- Avoiding unauthorized control by a 4-digit password.

KLEA Energy Analyzer has,

- 2 programmable alarm relay outputs, 2 digital outputs (totally 7 pieces in optional digital IO model), 2 digital input (totally 7 pieces in optional digital IO model), 1 piece of RS-485 communication port, 2/4 analog outputs (optional), battery supported real-time clock and memory.
- There are 6 keys and 160x240 graphical LCD on the front panel. By means of them, device settings and monitoring of measurement values can easily be accomplished.

1.5 KleaCom Software

Operator can remotely reach a Klea device via KleaCom software.

KleaCom software can communicate with only one Klea at the same time; operator can reach other Klea devices on the same network by changing the slave ID.

All measured/calculated parameters can be monitored with KleaCom. All settings of Klea can be changed/read via KleaCom software.

History (archive) data of Klea can be downloaded using KleaCom and this data can be listed in an MS Excel or WordPad file (selectable).

KleaCom software is included in the CD-ROM received with Klea package.

Latest version of KleaCom software can be downloaded from www.klemsan.com.tr.

1.6 KLEA Front Panel

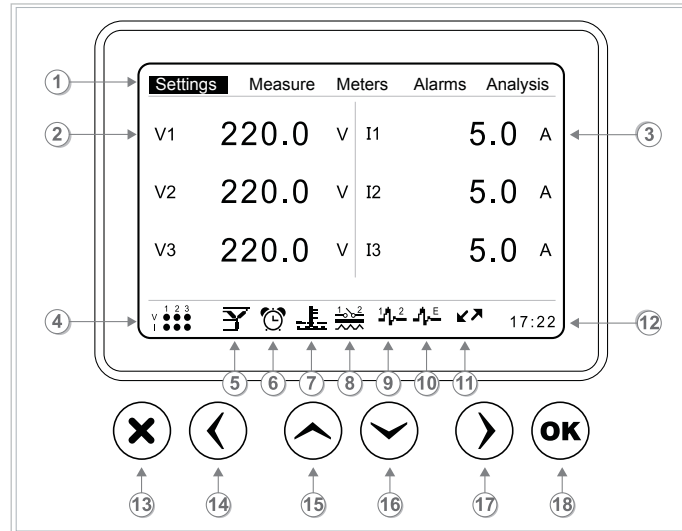

Fig. 1-1 KLEA Display

- 1 Menu
- 2 L-N voltages belonging to three phases
- 3 Currents of three phases
- 4 Presence/Absence of currents-voltages belonging to three phases, and phase sequence
- 5 Selected connection type
- 6 Alarm state symbol (for any alarm)
- 7 Temperature alarm state symbol (displayed only with a temperature alarm)
- 8 Alarm relay symbol (If 1st and/or 2nd alarm relay is assigned to any alarm and also if there is an alarm in the system at the same time, this symbol shall appear on the screen. "1" stands for 1st Alarm Relay and "2" stands for 2nd Alarm Relay)
- 9 KLEA digital output symbol ("1" indicates, digital output 1; and "2" indicates digital output 2. This symbol shall be displayed as long as width of the output pulse.)
- 10 KLEA digital output symbol (if there is an output from optional output3, output4, output5, output6 and output7, this symbol shall be displayed.)
- 11 RS485 communication symbol
- 12 Klea system time
- 13 X Key (in order to cancel any change or to return to the upper menu)
- 14 Left key
- 15 Up key
- 16 Down key
- 17 Right key
- 18 OK key (pressed in order to save any change or to access submenus)

1.7 Four-Quadrant Representation

The angle(θ) between voltage and current provides us information about the direction of energy flow. A positive sign for active/reactive power indicates that active/reactive power is consumed. And also a negative sign for active/reactive power indicates that active/reactive power is generated.

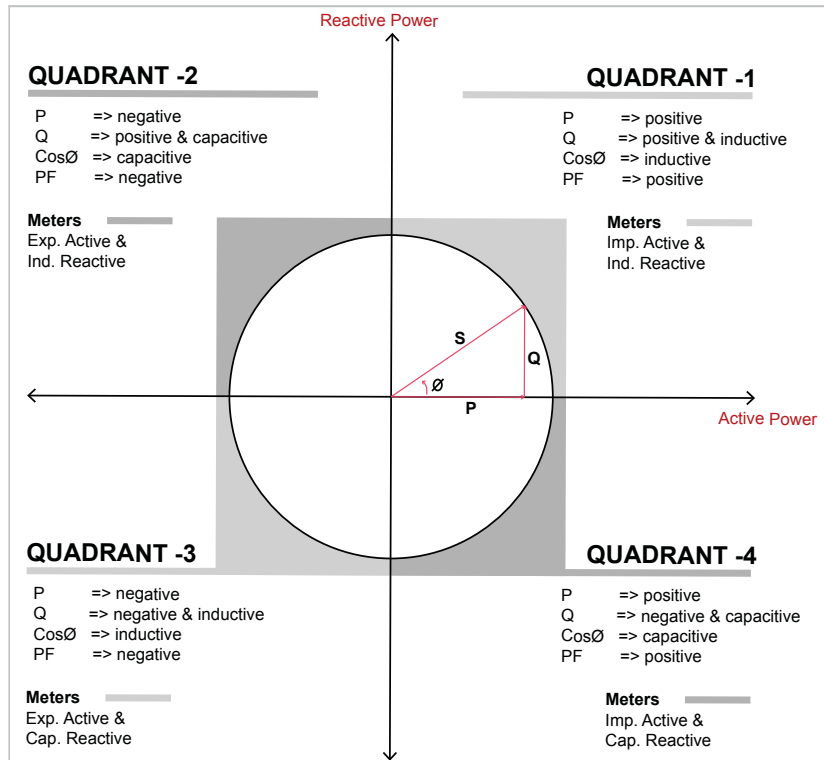

Fig. 1-2 Four-Quadrant Representation

NOTE: If the signs of active and reactive power are examined, it can be defined the quadrant that Klea measures.

E.g.;

- P= +10kWh, Q= +5kVAr => Quadrant-1
- P= -10kWh, Q= +5kVAr => Quadrant-2
- P= -10kWh, Q= -5kVAr => Quadrant-3
- P= +10kWh, Q= -5kVAr => Quadrant-4



SECTION 2 INSTALLATION



BÖLÜM 2 INSTALLATION

This section provides the information about installation, mounting, cable routing and connections of Klea.

2.1 Preparing for Installation

The purchased KLEA may not include all hardware options referred in this document. This situation does not constitute an impediment to the electrical installation.



Assembly and related connections of KLEA, must be implemented by authorized persons in accordance with the instructions of user manual.



The device must not be put into service if the operator is not sure that all connections are correctly accomplished.

2.2 Mounting

KLEA is placed vertically into the gap located in the panel.

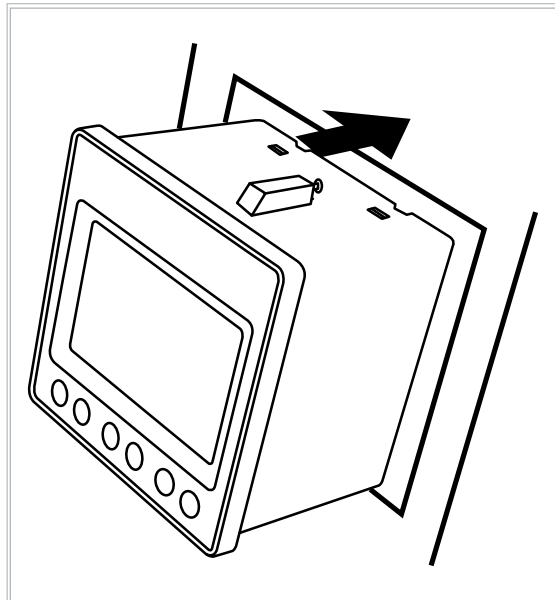

Fig. 2-1 Mounting KLEA into the Panel

After the KLEA is placed into the panel, fixing brackets should be installed on Klea and Klea should be fixed to the panel wall with the screws.

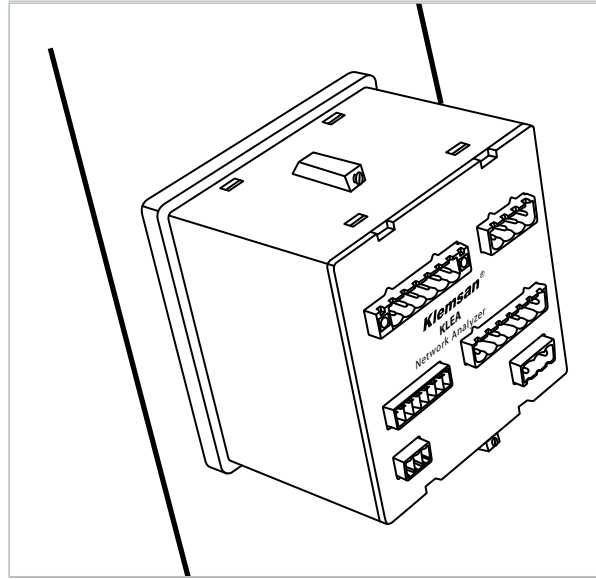

Fig. 2-2 Fixing KLEA to the panel

There are 2.5mm² and 1.5mm² screwed female terminal blocks connected to fixed male terminal blocks on KLEA. Remove female terminal blocks and loosen their screws.

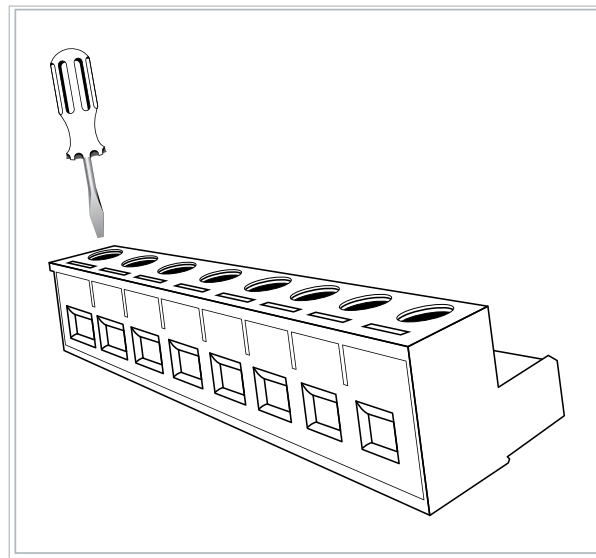

Fig. 2-3 Loosening of Terminal Block Screws



Before wiring up voltage and current ends to KLEA, you must be sure that the power is cut.



KLEA is connected to current transformer(s). Before disconnecting current transformer leads, be sure that they are short circuited elsewhere or connected to a parallel load which has sufficiently low impedance. Otherwise dangerously high voltages will be induced at the current transformer leads. Same phenomena also apply for putting into service.

The cable is placed into the related opening.

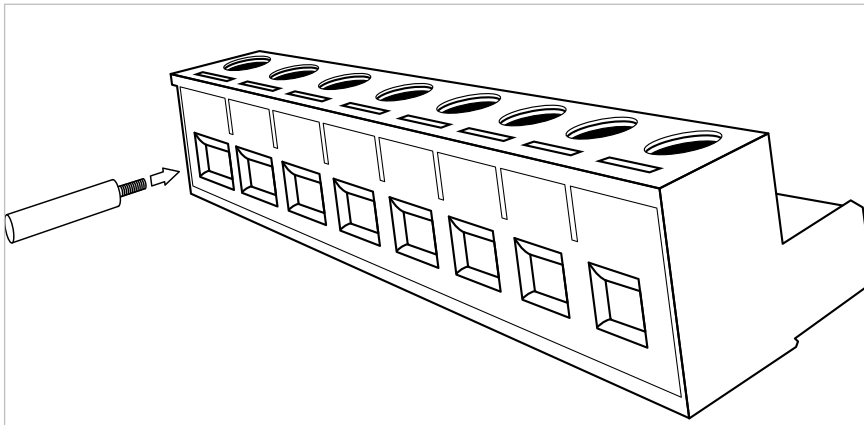

Fig. 2-4 Inserting Cable into the Terminal Block

After the cable is placed, the screws are tightened and the cable is fixed.

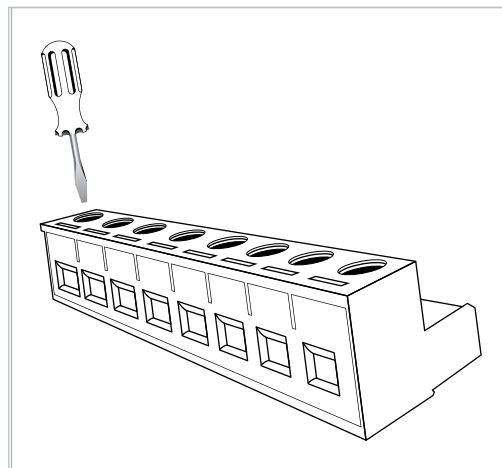

Fig. 2-5 Fixing the Cable to the Terminal Block

The Terminal Block is inserted into its seat located on KLEA.



If KLEA is used together with current transformers, please pay attention to the following warning. Threshold values for proper operation of current transformers differ according to the type and size of the transformers being used. Before applying the points mentioned in the following warning, please check that the measured current value is larger than the current threshold value of the current transformer (Refer to manual or datasheet of the current transformer).

For both of the warnings below, there must be a current in the system which is higher than the threshold value of the current transformer (if any).



If KLEA is placed in a panel which consumes power; The signs on Measure/Instantaneous/Active Power screen, should be positive, as the phases consume power. If there is a negative sign, turn off the device, cut off the panel power and then cross connect K and L ends of the current inputs belonging to the related phase(s). After that, check that all values are positive on Measure => Instantaneous => Active Power screen.



If KLEA is placed in a panel which generates power; The signs on Measure/Instantaneous/Active Power screen, should be negative, as the phases generate power. If there is a positive sign, turn off the device, cut off the panel power and then cross connect K and L ends of the current inputs belonging to the related phase(s). After that, check that all values are negative on Measure => Instantaneous => Active Power screen.

2.3 Wiring Diagrams

2.3.1 Three Phase Connection With Neutral (3P4W)

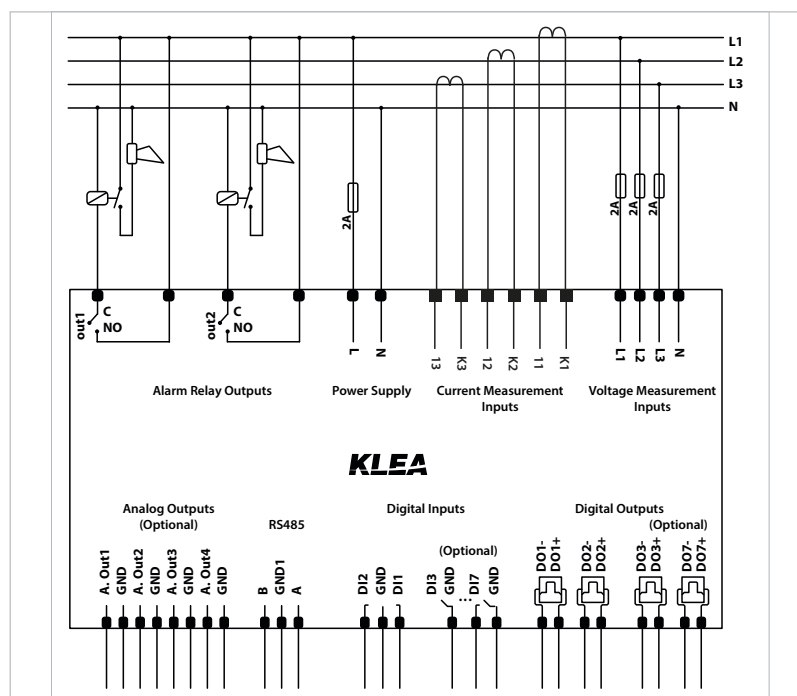

Fig. 2-6 KLEA Star (WYE) Connection Diagram

2.3.2 Three Phase Connection No Neutral (3P3W)

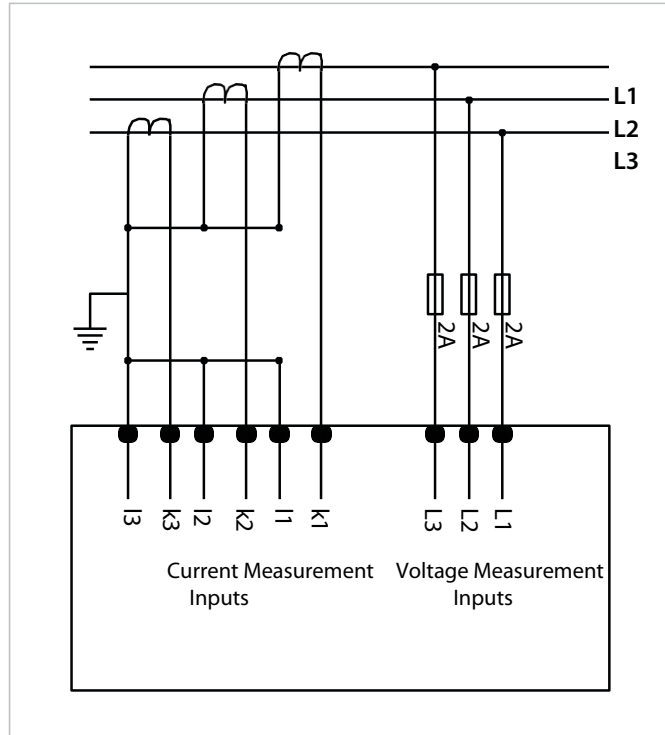

Fig. 2-7 KLEA 3 Phase Delta Connection Diagram

2.3.3 Three Phase No Neutral Aron Connection

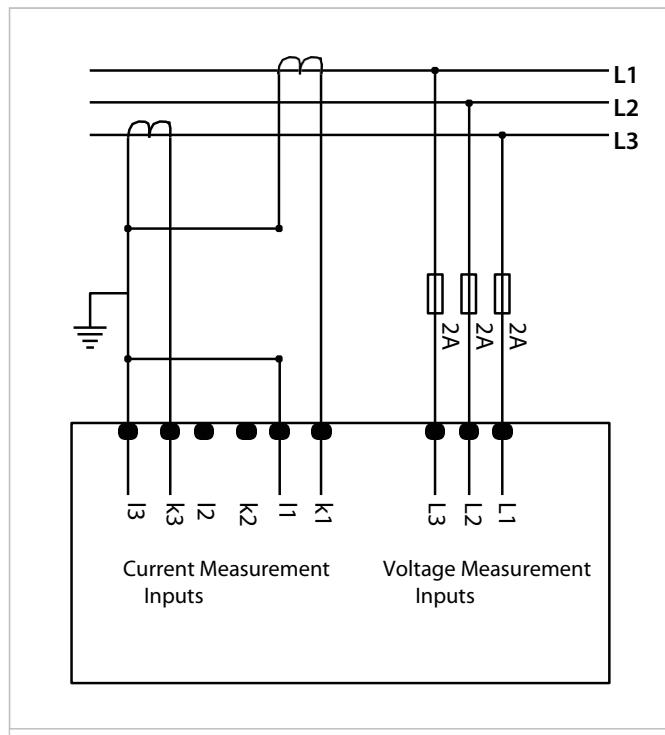

Fig. 2-8 KLEA Aron Connection Diagram

NOTE: Any two-phase current can be connected to the current measuring inputs. L1 and L3 are used in the figure above.

2.3.4 Digital Output Connection Diagram

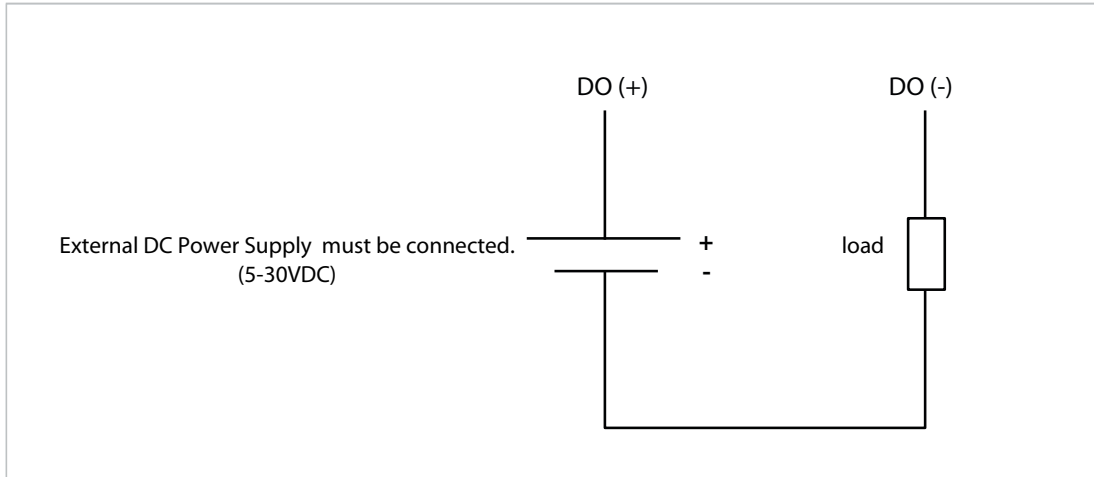

Fig. 2-9 Digital Output Connection Diagram

2.4 Dimensions

Dimensions are in millimeters.

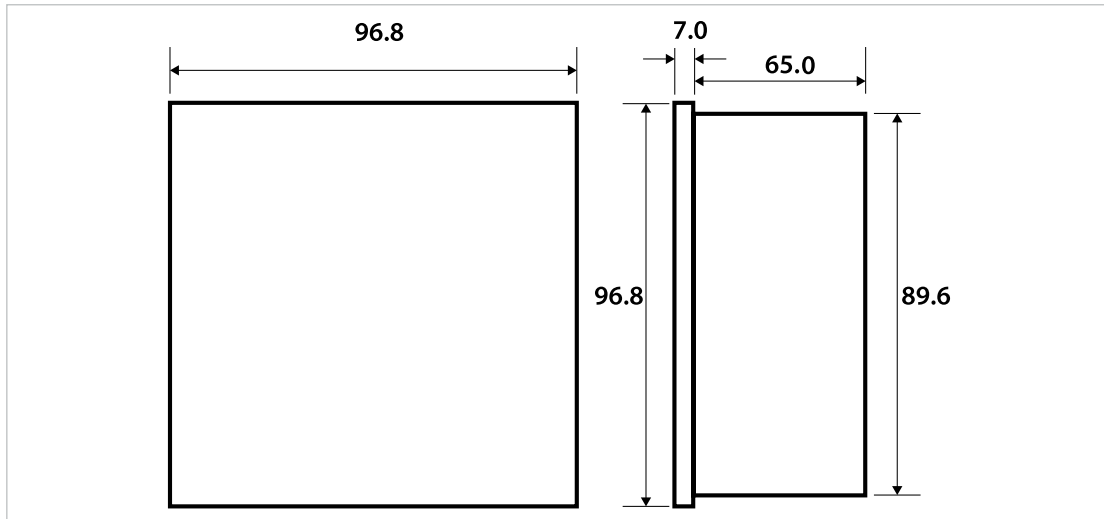
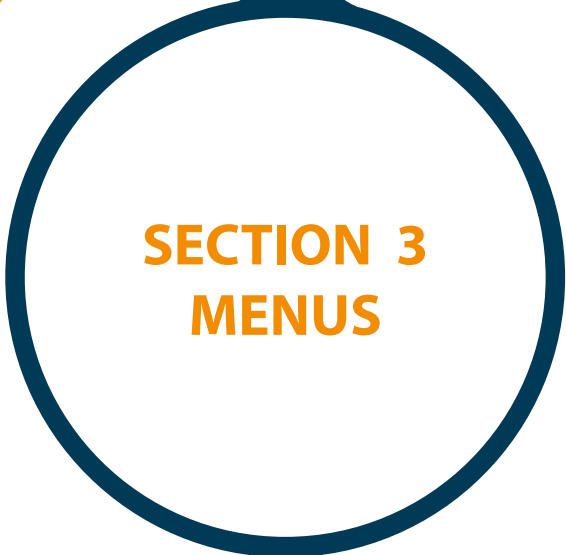

Fig. 2-10 Dimensions



**SECTION 3
MENUS**

BÖLÜM 3 MENUS

3.1 “First Power-on” Settings

After its receipt, when KLEA is switched on “for the first time”, the following page appears.

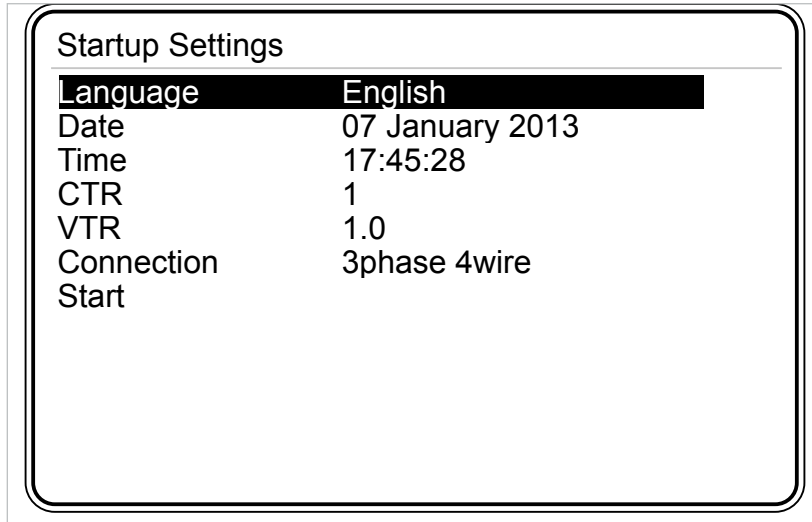

Fig. 3-1 First Power-on Settings

3.1.1 Dil / Language

When OK key is pressed on this tab, “Türkçe”, “English” and “Русский” options appear on the screen as seen below. Operator can scroll inside the options by pressing up and down keys and then should press “OK” to select the desired option. If language is selected as English, other tabs within this page will also be in English.

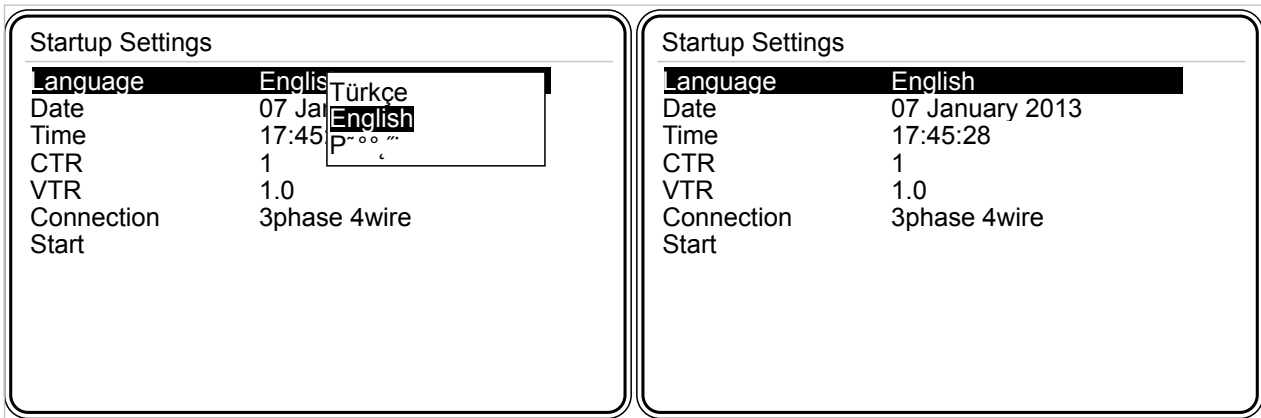

Fig. 3-2 Dil / Language

3.1.2 Date

In order to change the date, operator should press OK key, when “Date” tab is highlighted. Press right and left to move between day, month and year entries. Press up and down keys to change the values. Press OK key to complete date setting.

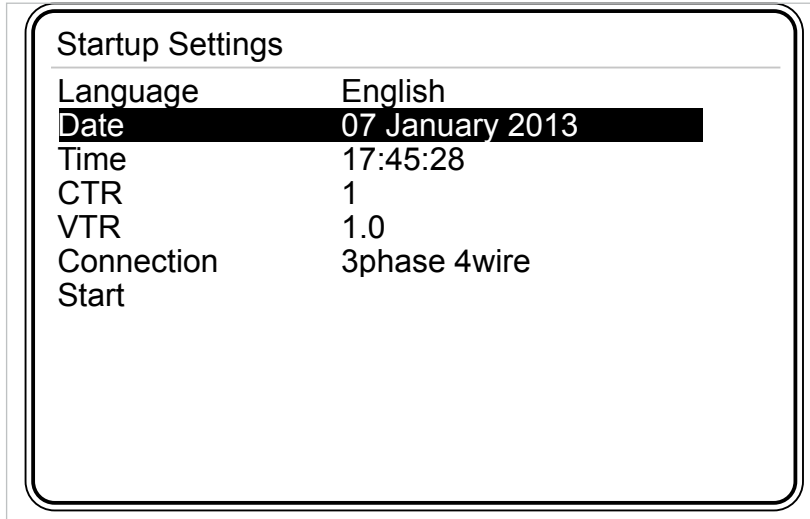

Fig. 3-3 Date

Example:

In order to enter “7 January 2013”:

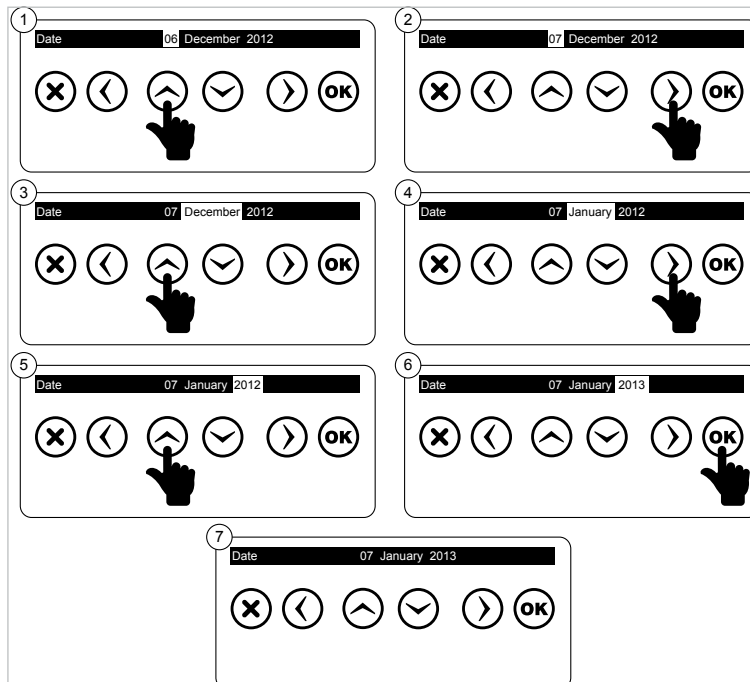

Fig. 3-4 Example for Setting the Date



3.1.3 Time

Time setting for KLEA is accomplished as explained in 3.1.2 Date menu.

3.1.4 Current Transformer Ratio (CTR)

In this tab, current transformer ratio is entered. The current transformer ratio can be adjusted between 1-5000. When this tab is highlighted; if the operator presses OK key, KLEA Virtual Keyboard will appear on the screen.

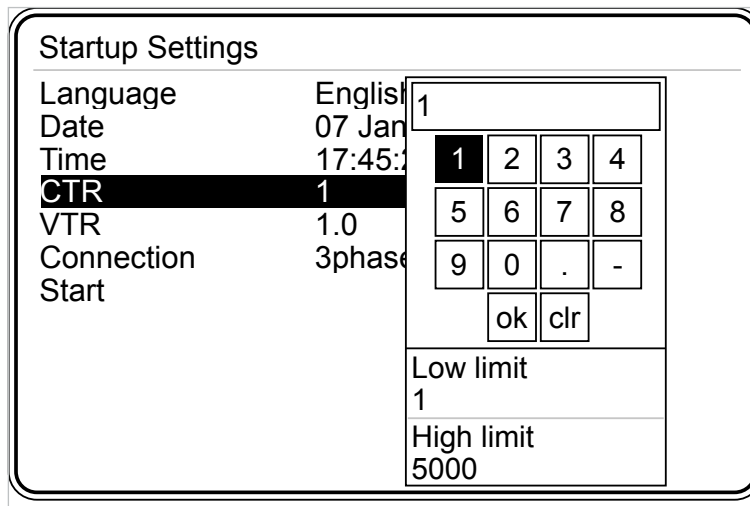



Fig. 3-5 Current Transformer Ratio

Use arrow keys (left, right, up and down) of Klea to navigate inside the virtual keyboard. In order to enter any number in the virtual keyboard as a value, when that number is highlighted, press OK key of Klea. When 'ok' box of virtual keyboard is highlighted, press 'OK' key of Klea to complete current transformer setting.

In case an incorrect digit is entered, scroll inside the virtual keyboard to select **clr** box. Then pres 'OK' key of Klea to erase erroneoos entered digit(s).



Caution:
 In order for KLEA to perform accurate measurements, current transformer ratio should be entered correctly.

E.g.:

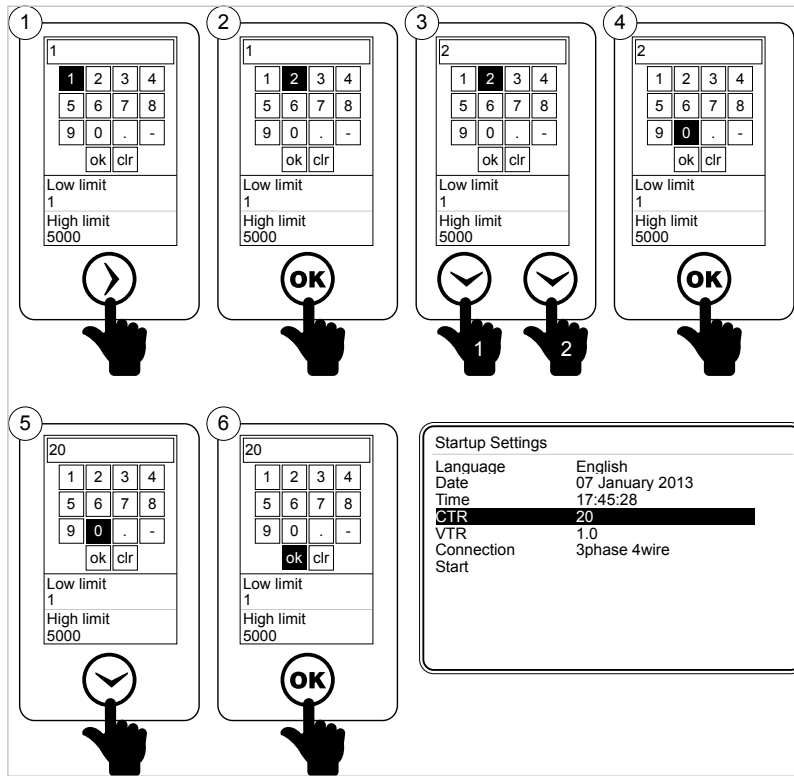



Fig. 3-6 Entering Values to the Virtual Keyboard

 To enter a decimal value, enter the integer part of the decimal number first. Then scroll inside virtual keyboard till box is highlighted. Press OK key of Klea to insert the decimal point. Following the point, enter the decimal part of the desired value.

 To enter a negative value, enter the number, move inside the virtual keyboard point to the negative sign box and press OK.

3.1.5 Voltage Transformer Ratio (VTR)

In this tab voltage transformer ratio is entered. (For Virtual Keyboard Refer to 3.1.4 E.g.). The voltage transformer ratio can be adjusted between 1 - 5000. To enter a decimal value, enter the integer part of the decimal number first. Then scroll inside virtual keyboard till box is highlighted. Press OK key of Klea to insert the decimal point. Following the point, enter the decimal part of the desired value.

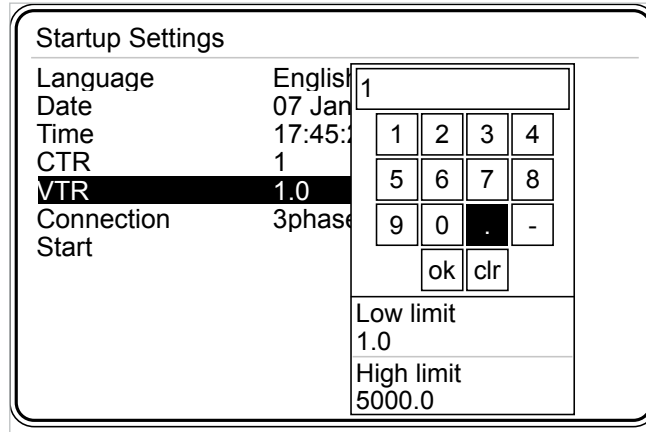

Fig. 3-7 Voltage Transformer Ratio



In order for KLEA to perform accurate measurements, current transformer ratio should be entered correctly.

3.1.6 Connection

This menu contains information about how to connect KLEA to the panel/electrical network.

There are 3 connection types:

- 3 phase – 4 wire connection
- 3 phase – 3 wire connection
- Aron connection

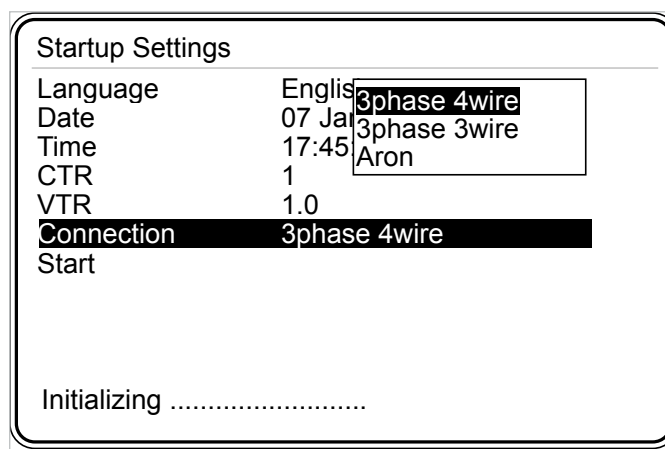

Fig. 3-8 Connection Types

3.1.7 Start

When Start tab is selected, press OK key to initialize Klea.

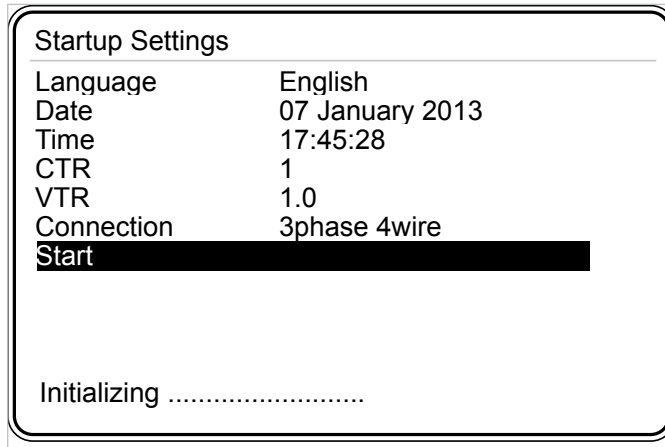

Fig. 3-9 Start



KLEA "first power-on" settings page only appears when KLEA is powered up for the first time after factory production. Following this first initialization, all the required settings (including "first power-on" page settings) can be accomplished via Settings menu of KLEA.

3.2 Startup Screen

After KLEA is turned on, following page appears.

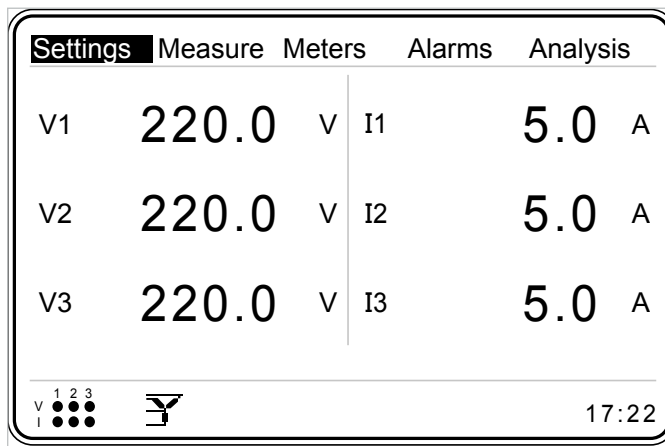

Fig. 3-10 Startup Screen

At the top of the screen, there are multiple selection menus.
 In the middle, instantaneous voltage and current values pertaining to each phase are shown.
 At the bottom left of the screen, current and voltage values of the three phases and connection type are shown.
 At the bottom right corner, system clock (KLEA time) is shown.
 Operator can navigate between the multiple selection menus by pressing right and left arrow keys. Press OK key to enter into any multiple selection menu.



When 3phase-4wire or ARON connection is selected, VL-N voltages are shown in startup screen.
 When 3phase-3wire connection is selected, VL-L voltages are shown in startup screen

3.2.1 Settings

KLEA settings are made in this menu. Select Settings menu and press OK key. When OK key is pressed, submenus will appear as seen in the Fig. 3-11. Under the Settings menu, the following submenus exist.

- Setup
- Date/Time
- System info
- Password
- Restart
- Default Settings

Settings	Measure	Meters	Alarms	Analysis
Setup				
Date / Time	0	V	I1	5.0 A
System info				
Password				
Restart	0	V	I2	5.0 A
Default settings				
V3	220.0	V	I3	5.0 A

At the bottom left of the screen, there is a diagram showing three phases (1, 2, 3) with a star symbol (Y) indicating a three-phase connection. At the bottom right, the system clock shows 17:22.

Fig. 3-11 Settings Menu

3.2.1.1 Setup Menu

The following submenus are available inside Setup menu:

- Network
- Device
- Energy
- Digital input
- Digital output
- Communication
- Alarm
- Clear

The user can scroll inside the menus by pressing up and down keys. Press OK key in order to access contents of each submenus (the submenus under the setup menu) .

In order for the new settings to be accepted by KLEA and stored in the memory, operator should navigate back (by pressing X key) to Startup Screen from the tab at which change has been made. When the operator returns to Startup page, "Settings changed. Save?" message will appear on the screen. If OK is pressed, changes will be accepted and stored in permanent memory. If X key is pressed, the changes will not be accepted by KLEA and will not be stored in permanent memory.



When "Settings changed. Save?" message appears on KLEA screen; if OK is pressed, setting changes will be accepted and stored in permanent memory. If X key is pressed, the changes will not be accepted and will not be stored in permanent memory.

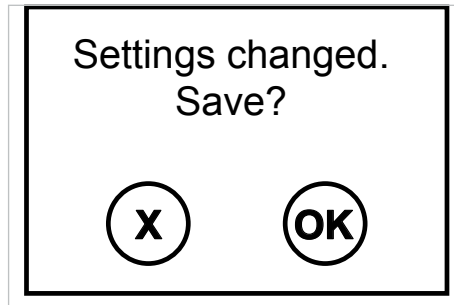

Fig. 3-12 KLEA Save Query

3.2.1.1.1 Network Menu

Electrical network related settings are accomplished in this menu.

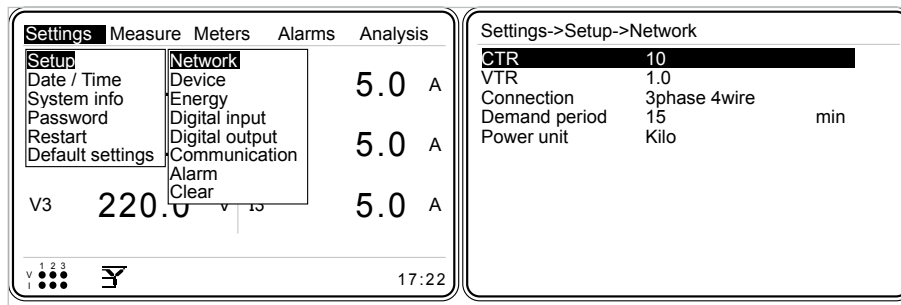

Fig. 3-13 Network Menu



3.2.1.1.1 Current Transformer Ratio

In this submenu current transformer ratio is entered. Inside Network menu, press up and down keys to select CTR. Press OK key and KLEA virtual keyboard will appear on the screen. The current transformer ratio (CTR) can be adjusted between 1 - 5000. (For Virtual Keyboard Refer to 3.1.4 E.g.)

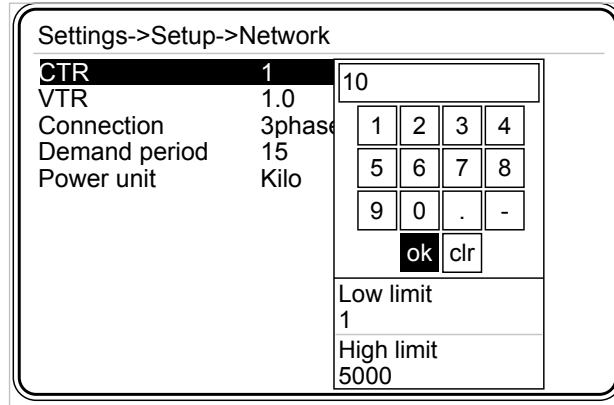

Fig. 3-14 Setting Current Transformer Ratio



In order for KLEA to perform accurate measurements, current transformer ratio should be entered correctly.

3.2.1.1.2 Voltage Transformer Ratio

In this submenu voltage transformer ratio is entered. Inside Network menu, press up and down keys to select VTR. Press OK key and KLEA virtual keyboard will appear on the screen. The voltage transformer ratio (VTR) can be adjusted between 1 - 5000.

(For Virtual Keyboard Refer to 3.1.4 E.g.). If a decimal number is to be entered as a VTR, with the help of Klea arrow keys point to the box on the Virtual Keyboard and press OK key.



In order for KLEA to perform accurate measurements, the voltage transformer ratio should be entered correctly.

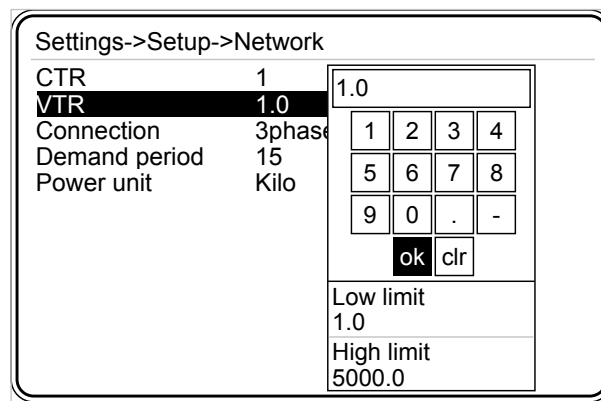

Fig. 3-15 Setting Voltage Transformer Ratio



3.2.1.1.1.3 Connection

KLEA may perform measurements with three different connection types.

- 3 phase – 4 wire connection
- 3 phase – 3 wire connection
- Aron connection

Inside Network menu, press up and down keys to select Connection. Press OK key and the above connection types will appear on the screen. Select the connection type and press OK to finish the setting.

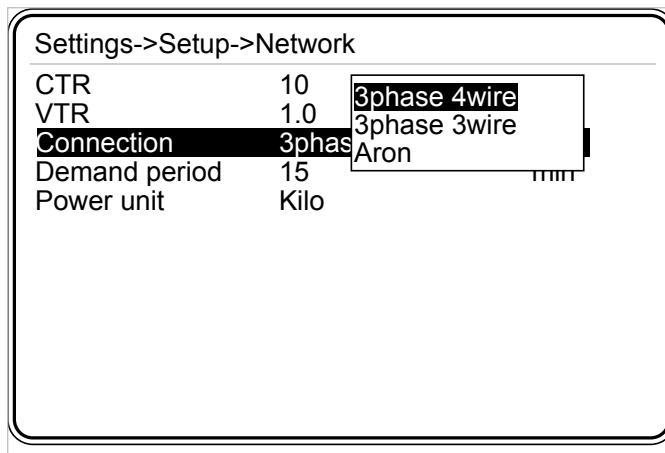

Fig. 3-16 Connection

3.2.1.1.1.4 Demand Period

Inside Network menu, press up and down keys to select (highlight) 'Demand period' menu item. When 'Demand period' is selected, press OK key and KLEA virtual keyboard will appear on the screen. Demand period can be adjusted between 1 - 60 minutes. (For Virtual Keyboard Refer to 3.1.4 E.g.)

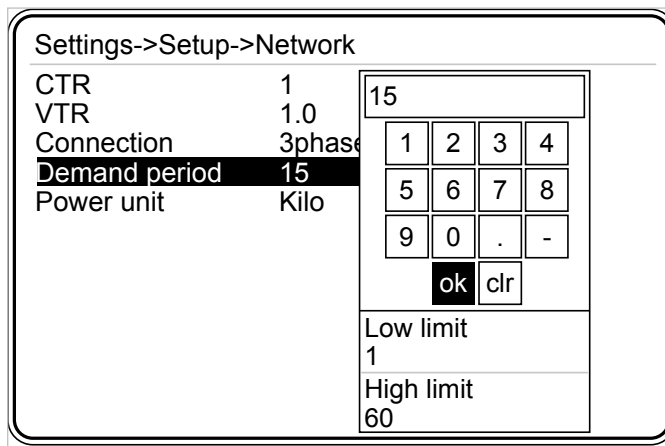

Fig. 3-17 Demand Period

3.2.1.1.1.5 Power Unit

KLEA displays total power or total energy values in two different units:

- Mega
- Kilo

Inside Network menu, press up and down keys to select (highlight) 'Power unit' menu item. When 'Power unit' is selected, press OK key and the aforementioned options will appear on the screen. Press up and down keys to select the desired option and press OK key to complete the setting.

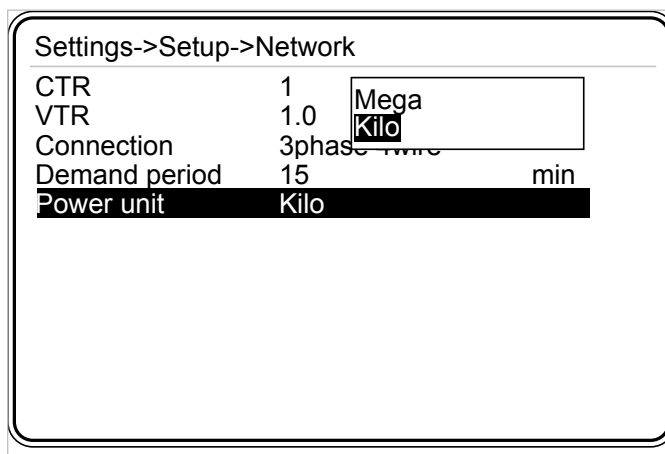

Fig. 3-18 Power Unit Setup

3.2.1.1.2 Device Menu

In this menu following settings can be accomplished.

- Language
- Contrast
- New Password
- Display on
- Display on Time

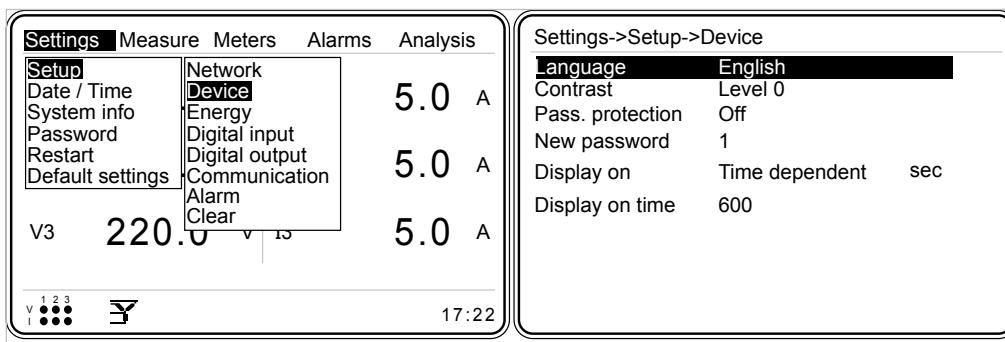

Fig. 3-19 Device Menu



3.2.1.1.2.1 Language

Inside Device menu, press up and down keys to select (highlight) 'Language' menu item. When 'Language' is selected, press OK key and the options in [Figure 3-20](#) will appear on the screen. Press up and down keys to select the desired option and press OK key to complete the setting.

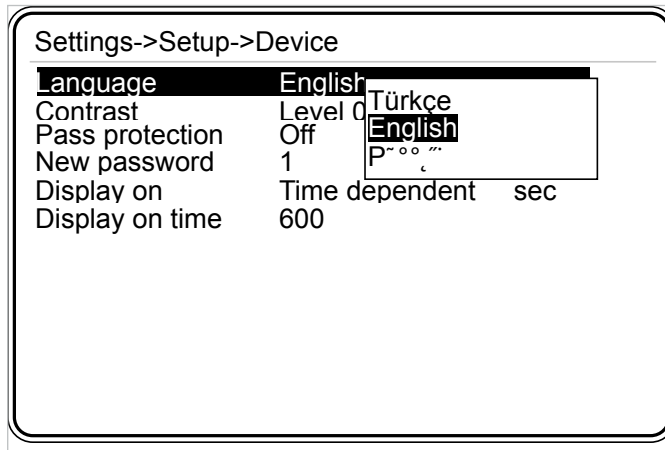

Fig. 3-20 Language Selection

3.2.1.1.2.2 Contrast

Inside Device menu, press up and down keys to select (highlight) 'Contrast' menu item. Press OK key and contrast levels will appear on the screen as seen in [Figure 3-21](#). Scroll inside contrast levels by pressing up and down keys; press OK key to select the desired option. Graphical LCD of KLEA darkens towards the Level 4; and lightens towards the Level -4.

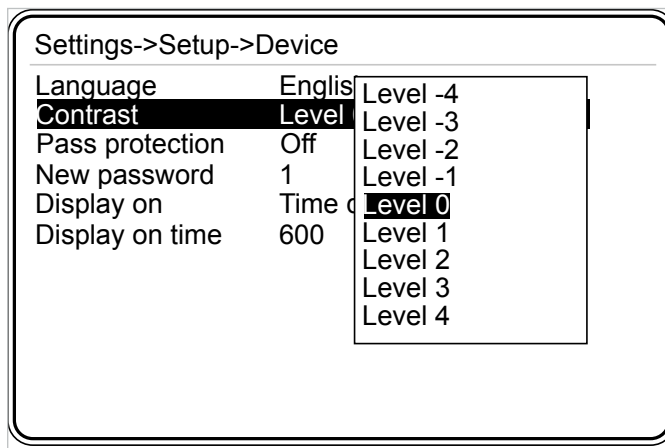

Fig. 3-21 Options for Contrast

3.2.1.1.2.3 Password Protection and New Password

KLEA has a password protection and default password protection is "Off". Default password is "1". New password can be adjusted between 1 - 9999 (For Virtual Keyboard Refer to 3.1.4 E.g.).

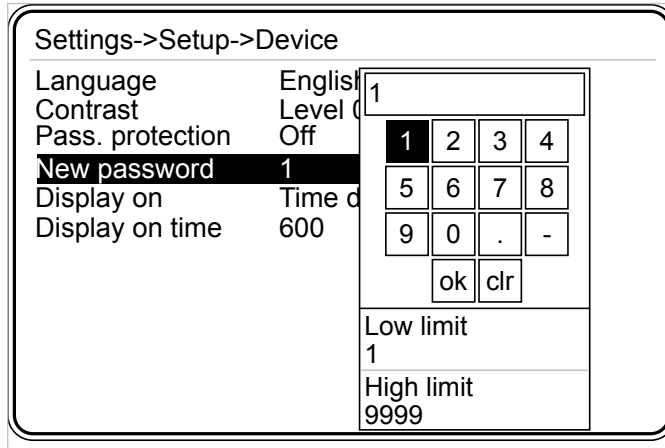

Fig. 3-22 Entering New Password

3.2.1.1.2.4 Display on Selection

- Continuous
- Time dependent

If continuous is selected, the backlight of KLEA graphical LCD will be turned on continuously. If 'Time dependent' option is selected, the backlight of the graphical LCD remains open as long as "display on time".

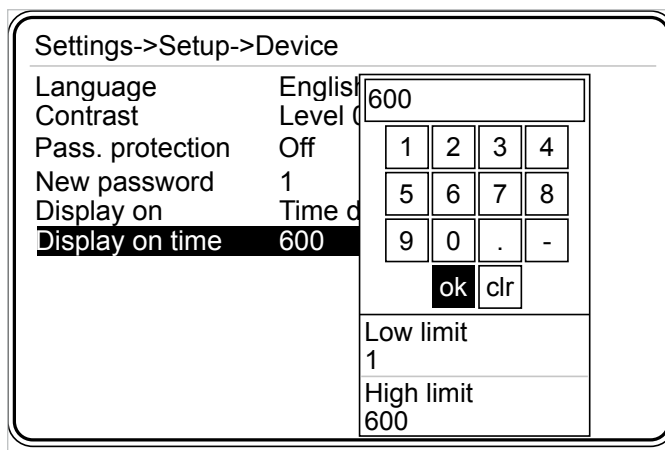

Fig. 3-23 Setting Display on Time

3.2.1.1.2.5 Display on Time

Displayon time can be adjusted between 10 ↔ 600 second.
 (For Virtual Keyboard Refer to 3.1.4 E.g.).

3.2.1.1.3 Energy Menu

Initial energy values for T1, T1_1, T1_2, T1_3 and T2 can be entered inside this menu. Thus, Toperator can synchronize the official electric meter with KLEA tariff meters. Operator can navigate inside Energy menu by pressing up and down keys.

Settings->Setup->Energy		
T1_1 start time	8	hr
T1_2 start time	16	hr
T1_3 start time	0	hr
Start of day	0	hr
Start of month	1	
T1 kWh	1000.0	kWh
T1 kWh E	1000.0	kWh
T1 kVArh Imp. I.	1000.0	kVArh
T1 kVArh Imp. C.	1000.0	kVArh
T1 kVArh Exp. I.	1000.0	kVArh
T1 kVArh Imp. C.	1000.0	kVArh
T2 kWh	1000.0	kWh

Fig. 3-24 Energy Menu

3.2.1.1.3.1 T1_1 start time

Electric meters can have more than one tariff and also individual tariffs can be sliced in time.

'T1_1' abbreviation refers to the first time slice of tariff 1 meter. T1_1 start time can be adjusted between 0-23 (for Virtual Keyboard Refer to 3.1.4 E.g.).

"T1 rate1" meter (the first time slice of T1 meter - T1_1) counts between T1_1 start time and T1_2 start time.

E.g.:

Assume that 'T1_1 start time' and 'T1_2 start time' are adjusted as 8 and 16 respectively. "T1 rate1 meter (T1_1)" counts starting from 08:00 and ceases at 16:00.

Meters->Imp. active			Settings->Setup->Energy		
T1	1000.0	kWh	T1_1 start time	8	hr
T1 rate 1	1000.0	kWh	T1_2 start time	16	hr
T1 rate 2	1000.0	kWh	T1_3 start time	0	hr
T1 rate 3	1000.0	kWh	Start of day	0	hr
T2	1000.0	kWh	Start of month	1	
			T1 kWh	1000.0	kWh
			T1 kWh E.	1000.0	kWh
			T1 kVArh Imp. I.	1000.0	kVArh
			T1 kVArh Imp. C.	1000.0	kVArh
			T1 kVArh Exp. I.	1000.0	kVArh
			T1 kVArh Exp. C.	1000.0	kVArh
			T2	1000.0	kWh

Fig. 3-25 T1_1 start time

NOTE: Assigned values also applies to the 4 quadrant counters.

("Exp. active "; Reactive R1 "; Reactive R2, ", " Reactive R3"; Reactive R4 ")

3.2.1.1.3.2 T1_2 Start time

'T1_2' abbreviation refers to the second time slice of tariff 1 me er.

T1_2 start time can be adjusted between 0-23 (for Virtual Keyboard Refer to 3.1.4 E.g.).

"T1 rate2" meter (the second time slice of T1 meter - T1_2) counts between T1_2 start time and T1_2 start time.

E.g.:

Assume that 'T1_2 start time' and 'T1_3 start time' are adjusted as 16 and 0 respectively. "T1 rate 2 meter (T1_2)" counts starting from 16:00 and ceases at 00:00.

Meters->Imp. active			Settings->Setup->Energy		
T1	1000.0	kWh	T1_1 start time	8	hr
T1 rate 1	1000.0	kWh	T1_2 start time	16	hr
T1 rate 2	1000.0	kWh	T1_3 start time	0	hr
T1 rate 3	1000.0	kWh	Start of day	0	hr
T2	1000.0	kWh	Start of month	1	
			T1 kWh	1000.0	kWh
			T1 kWh E.	1000.0	kWh
			T1 kVArh Imp. I.	1000.0	kVArh
			T1 kVArh Imp. C.	1000.0	kVArh
			T1 kVArh Exp. I.	1000.0	kVArh
			T1 kVArh Exp. C.	1000.0	kVArh
			T2 kWh	1000.0	kWh

Fig. 3-26 T1_2 StartTime

NOTE: Assigned values also applies to the 4 quadrant counters.

("Exp. active "," Reactive R1 "," Reactive R2, " , " Reactive R3"" Reactive R4 ")

3.2.1.1.3.3 T1_3 StartTime

'T1_3' abbreviation refers to the third time slice of tariff 1 me er.

T1_3 start time can be adjusted between 0-23 (for Virtual Keyboard Refer to 3.1.4 E.g.).

"T1 rate3" meter (the second time slice of T1 meter - T1_3) counts between T1_3 start time and T1_1 start time.

E.g.:

Assume that 'T1_3 start time' and 'T1_1 start time' are adjusted as 0 and 8 respectively. "T1 rate 3 meter (T1_3)" counts starting from 16:00 and ceases at 00:00.

Meters->Imp. active			Settings->Setup->Energy		
T1	1000.0	kWh	T1_1 start time	8	hr
T1 rate 1	1000.0	kWh	T1_2 start time	16	hr
T1 rate 2	1000.0	kWh	T1_3 start time	0	hr
T1 rate 3	1000.0	kWh	Start of day	0	hr
T2	1000.0	kWh	Start of month	1	
			T1 kWh	1000.0	kWh
			T1 kWh E.	1000.0	kWh
			T1 kVArh Imp. I.	1000.0	kVArh
			T1 kVArh Imp. C.	1000.0	kVArh
			T1 kVArh Exp. I.	1000.0	kVArh
			T1 kVArh Exp. C.	1000.0	kVArh
			T2 kWh	1000.0	kWh

Fig. 3-27 T1_3 start time

NOTE: Assigned values also applies to the 4 quadrant counters.

("Exp. active "," Reactive R1 "," Reactive R2, " , " Reactive R3"" Reactive R4 ")



If T1_1 and T1_2 have the same value, T1_1 and T1_3 counters count; If T1_1 and T1_3 have the same value T1_1 and T1_2 counters count; if T1_2 and T1_3 have the same value; T1_1 and T1_2 counters count, If T1_1, T1_2 and T1_3 have the same value, only T1_1 counter will count.



3.2.1.1.3.4 Start of day

Start of day can be adjusted between 0 - 23. (for Virtual Keyboard [Refer to 3.1.4 E.g.](#)).

3.2.1.1.3.5 Start of month

Start of month can be adjusted between 1 - 28. (for Virtual Keyboard [Refer to 3.1.4 E.g.](#))

The settings listed below (between [3.2.1.1.3.6](#) and [3.2.1.1.3.17](#)) are used to synchronize the system electric meter and KLEA meter. Each of the below items can be adjusted between 0.000→20000000000,0 (for Virtual Keyboard [Refer to 3.1.4 E.g.](#)).



Klea meters calculate energy by multiplying with CTR and VTR values. User should take this fact into account when entering the below initial energy values.

3.2.1.1.3.6 T1 kWh

"Initial" value for meter of "Imp. Active =>T1" can be entered in this tab.

3.2.1.1.3.7 T1 kWh E

"Initial" value for meter of "Exp. Active=> T1" can be entered in this tab.

3.2.1.1.3.8 T1 kWh Imp. I.

"Initial" value for meter of "Reactive R1=>T1" can be entered in this tab.

3.2.1.1.3.9 T1 kWh Imp. C.

"Initial" value for meter of "Reactive R2=>T1" can be entered in this tab.

3.2.1.1.3.10 T1 kVArh Exp. I.

"Initial" value for meter of "Reactive R3=> T1" can be entered in this tab/

3.2.1.1.3.11 T1 kVArh Exp. C.

"Initial" value for meter of "Reactive R4=>T1" can be entered in this tab.



3.2.1.1.3.12 T2 kWh

"Initial" value for meter of " Imp. Active=>T2" can be entered in this tab.

3.2.1.1.3.13 T2 kWh E.

"Initial" value meter of " Exp. active=>T2" can be entered in this tab.

3.2.1.1.3.14 T2 kVArh Imp. I.

"Initial" value for meter of "Reactive R1=>T2" can be entered in this tab.

3.2.1.1.3.15 T2 kVArh Imp. C.

"Initial" value for meter of "Reactive R2=>T2" can be entered in this tab.

3.2.1.1.3.16 T2 kVArh Exp. I.

"Initial" value for meter of "Reactive R2=>T2" can be entered in this tab.

3.2.1.1.3.17 T2 kVArh Exp. C.

"Initial" value for meter of "Reactive R4=>T2" can be entered in this tab.

NOTE: "T1 rate1", "T1 rate2" ve "T1 rate3" is made from "Settings => Setup => Energy" menu. These appointments should be made using Modbus communications over the computer. Energy value that will be assigned, must be written to corresponding modbus address. Related ModBus addresses are given below. For more information refer to "Table 4-4.

- 2032. modbus address: "Initial" energy value for meter of "Imp. active => T1 rate1" can be entered.
- 2034. modbus address: "Initial" energy value for meter of "Exp. active => T1 rate1" can be entered.
- 2036. modbus address: "Initial" energy value for meter of "Reactive R1 => T1 rate1" can be entered.
- 2038. modbus address: "Initial" energy value for meter of "Reactive R2 => T1 rate1" can be entered.
- 2040. modbus address: "Initial" energy value for meter of "Reactive R3 => T1 rate1" can be entered.
- 2042. modbus address: "Initial" energy value for meter of "Reactive R4 => T1 rate1" can be entered.
- 2044. modbus address: "Initial" energy value for meter of "Imp. active => T1 rate2" can be entered.
- 2046. modbus address: "Initial" energy value for meter of "Exp. active => T1 rate2" can be entered.
- 2048. modbus address: "Initial" energy value for meter of "Reactive R1 => T1 rate2" can be entered.
- 2050. modbus address: "Initial" energy value for meter of "Reactive R2 => T1 rate2" can be entered.
- 2052. modbus address: "Initial" energy value for meter of "Reactive R3 => T1 rate2" can be entered.

- 2054. modebus address: "Initial" energy value for meter of "Reactive R4 => T1 rate2" can be entered.
- 2056. modebus address: "Initial" energy value for meter of "Imp. active => T1 rate3" can be entered.
- 2058. modebus address: "Initial" energy value for meter of "Exp. active => T1 rate3" can be entered.
- 2060. modebus address: "Initial" energy value for meter of "Reactive R1 => T1 rate3" can be entered.
- 2062. modebus address: "Initial" energy value for meter of "Reactive R2 => T1 rate3" can be entered.
- 2064. modebus address: "Initial" energy value for meter of "Reactive R3 => T1 rate3" can be entered.
- 2066. modebus address: "Initial" energy value for meter of "Reactive R4 => T1 rate3" can be entered.

3.2.1.1.4 Digital Input Menu

Digital input menu consists of Input1 and Input2 menus. KLEA digital inputs are used in order to activate Tariff 2 meter and/or to count a digital signal.

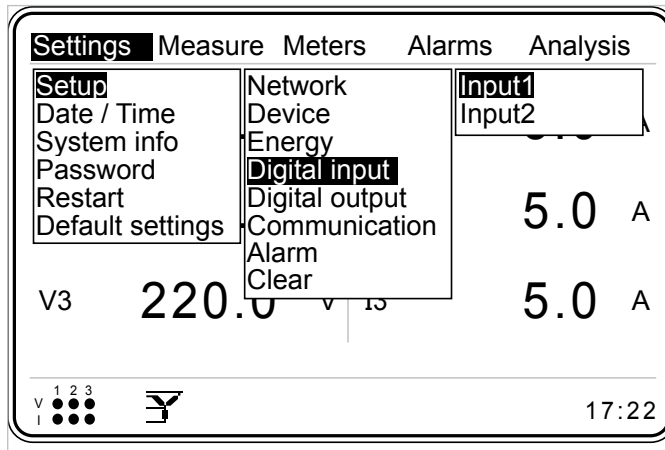

Fig. 3-28 Digital Input Menu

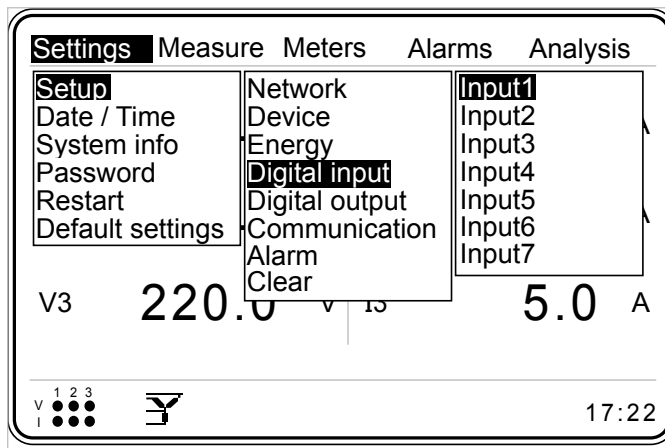

Fig. 3-29 Digital Input Menu (With IO option)

3.2.1.1.4.1 Input1 Menu

Input1 operates when DI1 and GND pins of KLEA are short circuited. Input1 menu has two settings:

- Mode
- Delay

3.2.1.1.4.1.1 Mode

Mode options are as seen below (Fig. 3-30). Press up and down keys to scroll inside options. Press OK key to select the desired option.

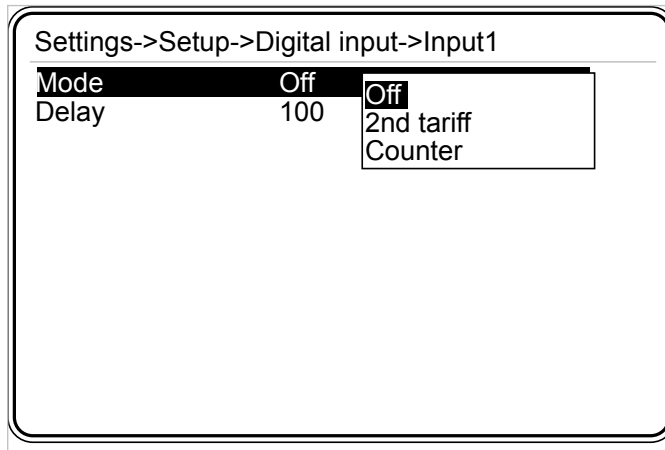

Fig. 3-30 Mode Selection

- Assume that for digital input 1, '2nd tariff' is selected as the mode setting. Under this condition, when digital input 1 is short circuited (activated), tariff 1 meter will stop and tariff 2 meter will start to count.
- Assume that for digital input 1, 'Counter' is selected as the mode setting. Under this condition, each time DI1 and GND pins are short-circuited, "Meters->Digital input->Digital input1 counter" counts (Fig. 3-30).

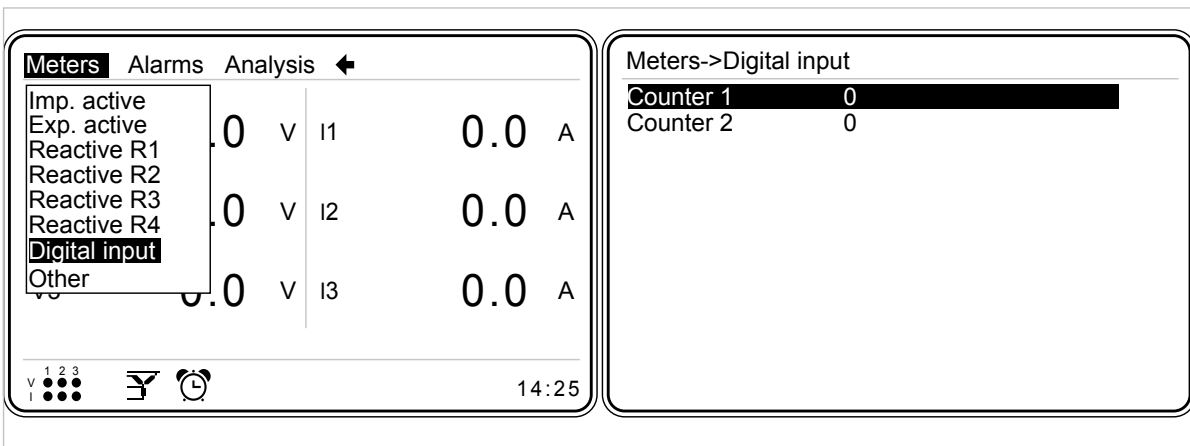

Fig. 3-31 Digital Input1 Counter

3.2.1.1.4.1.2 Delay

Digital input delay can be adjusted between 10↔2000 milliseconds. In order for '2nd tariff' or 'Counter' modes to be activated; DI1 and GND pins should be short-circuited at least "delay" period of time. (for Virtual Keyboard Refer to 3.1.4 E.g.).

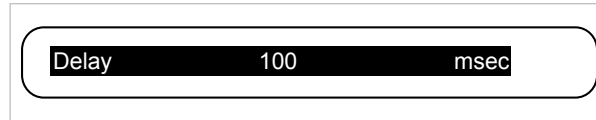

Fig. 3-32 Delay

E.g.:

Digital input : Input1
 Mode : Counter,
 Delay : 200 msec

When DI1 and GND pins are short-circuited for minimum 200 msec, 'Input 1 Counter' increments by 1.

E.g.:

Digital input : Input1
 Mode : Tariff
 Delay : 200 msec

In order for the Tariff 2 meter to be active, DI1 and GND pins should be short-circuited for minimum 200 msec. Tariff 2 meter will be active during the course of short circuit time.

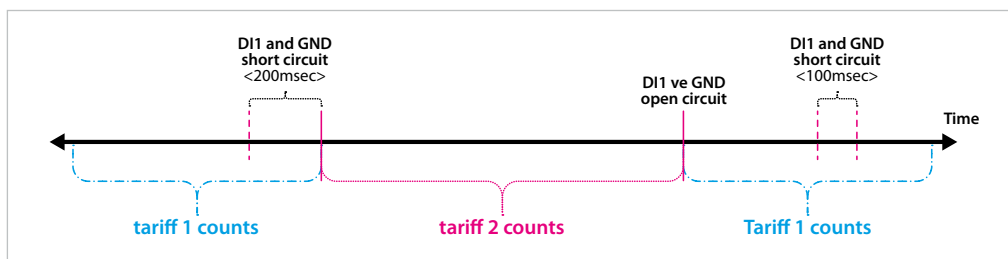

Fig. 3-33 Tariff 1 or Tariff 2 ctivation

3.2.1.1.4.2 Input 2 Menu

Input 2 applications and settings are the same as Input1. Digital input2 operates with DI2 and GND pins.

3.2.1.1.4.3 Input 3 Menu (optional)

Input 3 is applicable to optional digital IO Klea models. Input 3 applications and settings are the same as Input1. Digital input3 operates with DI3 and GND pins.

3.2.1.1.4.4 Input 4 Menu (optional)

Input 4 is applicable to optional digital IO Klea models. Input 4 applications and settings are the same as Input1. Digital input4 operates with DI4 and GND pins.

3.2.1.1.4.5 Input 5 Menu (optional)

Input 5 is applicable to optional digital IO Klea models. Input 5 applications and settings are the same as Input1. Digital input5 operates with DI5 and GND pins.

3.2.1.1.4.6 Input 6 Menu (optional)

Input 6 is applicable to optional digital IO Klea models. Input 6 applications and settings are the same as Input1. Digital input6 operates with DI6 and GND pins.

3.2.1.1.4.7 Input 7 Menu (optional)

Input 7 is applicable to optional digital IO Klea models. Input 7 applications and settings are the same as Input1. Digital input7 operates with DI7 and GND pins.

3.2.1.1.5 Digital Output Menu

It comprises of Output1 and Output menus.

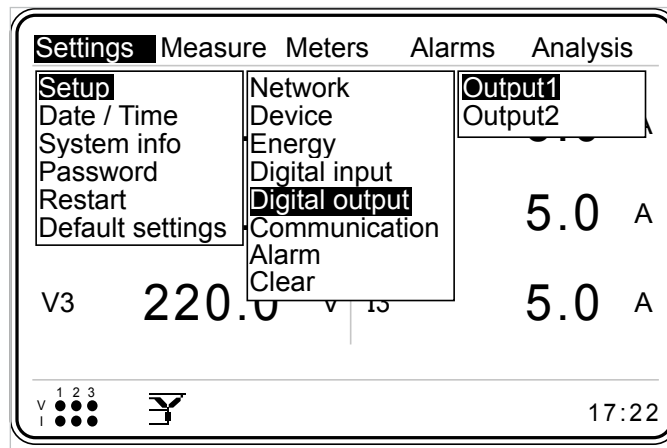

Fig. 3-34 Digital Output Menu

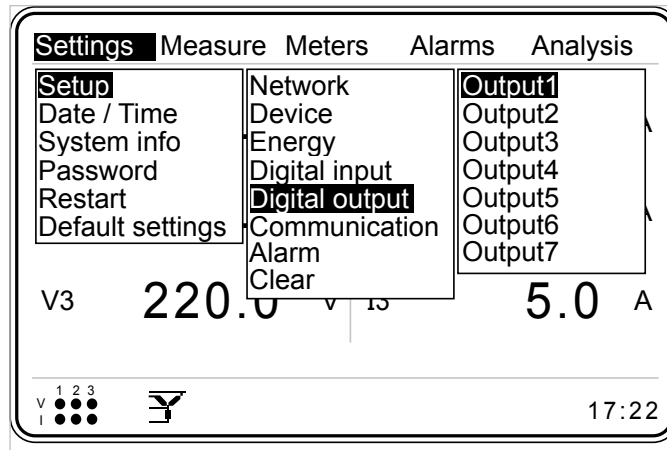

Fig. 3-35 Digital Output Menu (optional digital I/O model)

3.2.1.1.5.1 Output1 Menu

Output1 gives output from D01- and D01+ pins

Mode: Press up and down keys to navigate between digital outputs. Press OK on the desired output, and options seen in Fig. 3-36 will appear. Any of them can be assigned as output1 operating mode.

Mode setting has the following options.

- Off
- T1 kWh
- T1 kWh E.
- T1 kVArh I. Ind.
- T1 kVArh I. Cap.
- T1 kVArh E. Ind.
- T1 kVArh E. Cap.
- T2 kWh
- T2 kWh E.
- T2 kVArh I. Ind.
- T2 kVArh I. Cap.
- T2 kVArh E. Ind.
- T2 kVArh E. Cap.
- Digital Input

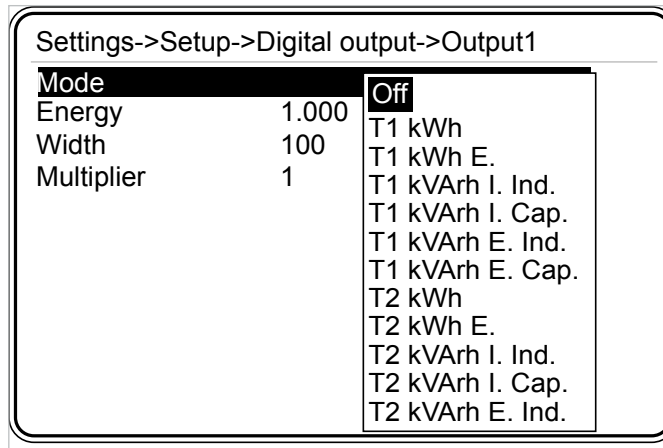

Fig. 3-36 Output 1 Menu

Energy:

When selected meter option(mode option) counts for the selected “energy” value, Output1 generates a pulse (for Virtual Keyboard Refer to 3.1.4 E.g.).

Width:

It can be adjusted between 50 – 2500 msec (for Virtual Keyboard Refer to 3.1.4 E.g.).

Multiplier:

Multiplier is of use only when “Output1->mode” is adjusted as “Digital input”.

When “digital input1 counter” (Refer to Digital Input 3.2.3.2), reaches the ‘multiplier’; “digital output1” generates a pulse from DO1+ and DO1- pins.

It can be adjusted between 1 - 10000 (for Virtual Keyboard Refer to 3.1.4 E.g.).

Second example explains this implementation.

E.g.:

Assume the settings are as below,

Digital output : Output1
 Mode : T1 kWh
 Energy : 2
 Width : 100msec

Assume that, Tariff 1 import active previous value is 1.1kWh. When T1 kWh reaches to 3.1kWh, 5.1kWh, 7.1kWh etc. a pulse of 100msec will be generated at the outputs of DO1- and DO1+.

E.g.:

Digital output : Output1
 Mode : Digital input
 Energy : When connection type is digital input, the Energy tab is not used.
 Width : 100msec
 Multiplier : 100

Assume also that Digital input1 mode had been adjusted as“counter”. In this case, when Counter1 reaches 100 or multiples of 100, a pulse of 100 msec will be will be generated at the output pins DO1- and D01+.

Assume that the digital input 1 counter value was 35 before multiplier adjustment. Assume also that operator adjusts ‘Multiplier’ as 100. Under these conditions, Output 1 generates a pulse when digital input 1 counter reaches the values 135, 235, 335, 435 and so on.

3.2.1.1.5.2 Output Menu

Output 2 applications and settings are the same as Output1. Output generates pulse from DO2+ and DO2- pins.

3.2.1.1.5.3 Output3 Menu (optional)

Output 3 applications and settings are the same as Output1. Output3 generates pulse from DO3+ and DO3- pins.

3.2.1.1.5.4 Output4 Menu (optional)

Output 4 applications and settings are the same as Output1. Output4 generates pulse from DO4+ and DO4- pins.

3.2.1.1.5.5 Output5 Menu (optional)

Output 5 applications and settings are the same as Output1. Output5 generates pulse from DO5+ and DO5- pins.

3.2.1.1.5.6 Output6 Menu (optional)

Output 6 applications and settings are the same as Output1. Output6 generates pulse from DO6+ and DO6- pins.

3.2.1.1.5.7 Output7 Menu (optional)

Output 7 applications and settings are the same as Output1. Output7 generates pulse from DO7+ and DO7- pins.

3.2.1.1.6 Analog Output Menu (Optional)

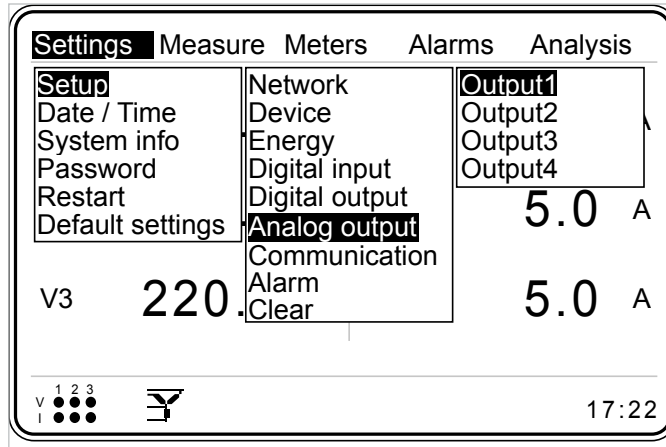

Fig. 3-37 Analog Output Menu

KLEA has two different optional analog output models; 2 analog output and 4 analog output models.

Operator can adjust KLEA to give output from analog output channels for the following parameters: voltage, current, active power, reactive power, apparent power, frequency, phase-phase voltages, neutral current, total current, total active power, total reactive power and total apparent power pertaining to L1, L2, L3 phases.

Analog output channels can be adjusted to generate signals as 0-5V, 0-10V, -5-5V, -10- 10V, 0-20mA, 4-20mA. Analog output menu comprises of the following submenus.

Output1 (available in 2 analog and 4 analog outputs models)

Output (available in 2 analog and 4 analog outputs models)

Output3 (available only in 4 analog outputs model)

Output4 (available only in 4 analog outputs model)

3.2.1.1.6.1 Output1 Menu

Output1 menu comprises of the following submenus

- Input mode
- Output conn.
- Min. Value
- Max. Value
- Multiplier

Settings->Setup->Analog output->Output1	
Input mode	V1 (L-N)
Output conn.	0-5V
Min. value	0.0
Max. value	0.0
Multiplier	1

Fig. 3-38 Output1

3.2.1.1.6.1.1 Input mode

Analog output will generate a signal in accordance with the parameter selected in Input mode tab. Analog output examples will clarify the application of settings.

Input mode options are as follows:

- V1(L-N)
- V2(L-N)
- V3(L-N)
- I1
- I2
- I3
- P1
- P2
- P3
- Q1
- Q2
- Q3
- S1
- S2
- S3
- F
- IN
- VLL12
- VLL23
- VLL31
- I tot.
- P tot.
- Q tot.
- S tot.

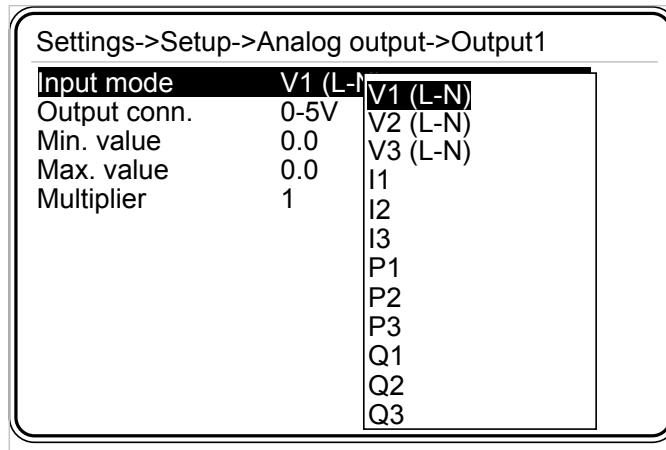

Fig. 3-39 Input mode

3.2.1.1.6.1.2 Output connection

Inside Output1 menu, press up and down keys to select (highlight) 'Output connection' menu item. When 'Output connection' is selected, press OK key and the options in Fig. 3-40 will appear on the screen. Press up and down keys to select the desired option and press OK key to complete the setting.

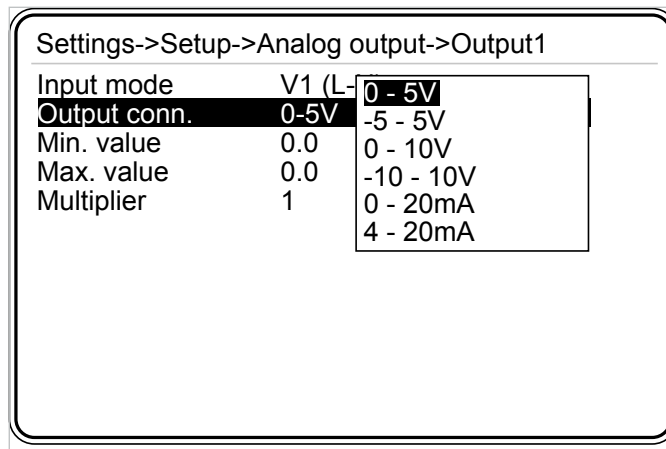

Fig. 3-40 Output connection

Assume that for analog output 1, output connection was selected as 0-5V (Refer to Fig. 3.40). Then, operator should adjust the "analog output 1" dip switch as seen in Fig. 3.41 (Vout1 -> ON; Iout1 -> OFF). After the dip switch adjustment, setting will be completed.

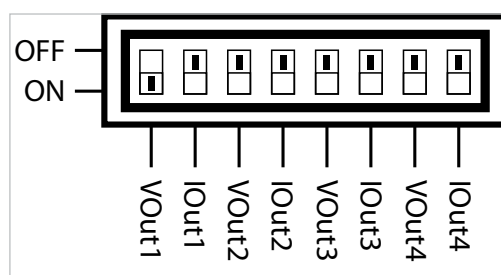

Fig. 3-41 Vout1 -> ON; Iout1 -> OFF

Assume that for analog output 1, output connection was selected as 4-20 mA (refer to Fig. 3.40). Then, operator should adjust the “analog output 1” dip switch as seen in Fig. 3.42 (Vout1 -> OFF; Iout1 -> ON). After the dip switch adjustment, setting will be completed.

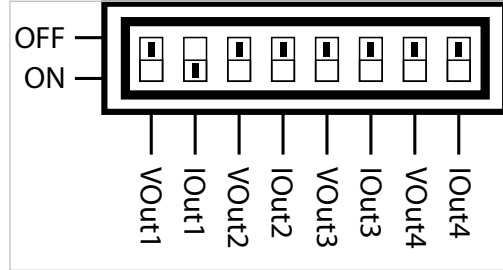

Fig. 3-42 Vout1 -> OFF; Iout1 -> ON



In order to obtain voltage output, Vout1 should be set to ON, and Iout1 should be set to OFF. If both switches are ON or OFF at the same time, analog output will not operate correctly.



In order to obtain current output, Vout1 should be set to OFF, and Iout1 should be set to ON. If both switches are ON or OFF at the same time, analog output will not operate correctly.



If the setting of output connection and setting of the dip switch are incompatible, related analog output will not operate correctly.

3.2.1.1.6.1.3 Min. value

The minimum value for the selected input mode. Refer to 3.2.1.1.6.1.5 Multiplier setting.

3.2.1.1.6.1.4 Max. value

The maximum value for the selected input mode Refer to 3.2.1.1.6.1.5 Multiplier setting.



If “Min. value” and “Max. value” are adjusted to be the same, then analog output will not operate.

3.2.1.1.6.1.5 Multiplier

When ‘Multiplier’ is selected, press OK key and the options in Fig. 3-43 will appear on the screen. Press up and down keys to select the desired option and press OK key to complete the setting. Multiplier coefficient options are as follows:

- 1
- Kilo (1000)
- Mega (1000000)

For example, assume that 10000000W and 350000000W are required to be entered for min. and max. values. In this case, if operator selected Mega in multiplier tab, then it will be sufficient to enter 10 and 350 for min. and max. values.

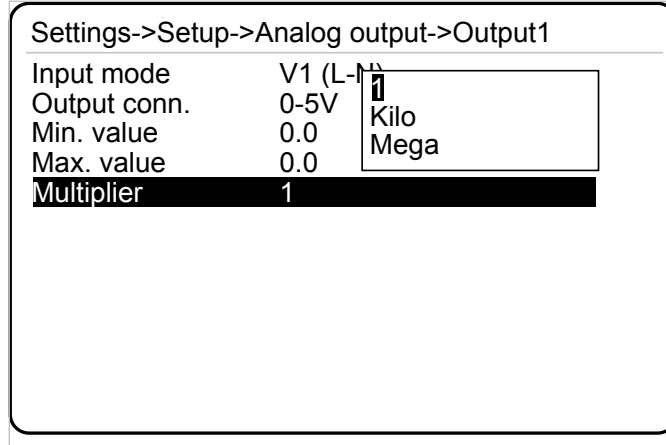

Fig. 3-43 Multiplier

Klea can output 0 – 5V, -5 – 5V, 0 – 10V, -10 – 10V, 0 – 20mA and 0 – 20mA range signals from AOX-GND pins.

When the value of 'Input mode' parameter falls below 'Min. value' with an amplitude less than 2.5%; or exceeds 'Max. value' with an amplitude again less than 2.5%; output signal will linearly follow this change. For 'Output conn.' types whose low limit is zero, output signal will not fall below zero; only high limit will change linearly up to 2.5% of its value.

In summary, output signals from AOX-GND pins will operate as follows:

0 – 5 V	➔	0 – 5.125 V	(output signal low value will not fall below zero)
-5 – 5 V	➔	-5.125 – 5.125 V	
0 – 10 V	➔	0 – 10.25 V	(output signal low value will not fall below zero)
-10 – 10 V	➔	-10.25 – 10.25 V	
0 – 20 mA	➔	0 – 20.5 mA	(output signal low value will not fall below zero)
4 – 20 mA	➔	3.9 – 20.5 mA	

When the value of 'Input mode' parameter falls below 'Min. value' with an amplitude more than 2.5%; or exceeds 'Max. value' with an amplitude again more than 2.5%; output signal will change. In this case, output signals from AOX-GND pins will operate as follows in order to indicate that there is a problem in the electrical network:

for 0 – 5 V setting; AOX-GND signal amplitude will be	10 V
for -5 – 5V setting; AOX-GND signal amplitude will be	10 V
for 0 – 10 V setting; AOX-GND signal amplitude will be	10.8 V
for -10 – 10 V setting; AOX-GND signal amplitude will be	10.8 V
for 0 – 20 mA setting; AOX-GND signal amplitude will be	21.6 mA
for 4 – 20 mA setting; AOX-GND signal amplitude will be	21.6 mA

The amplitude of analog output signal on AO1-GND pins will be as calculated by the following formula.

$$AO1-GND = \left[\frac{AO1 \text{ con.highlimit} - AO1 \text{ con.lowlimit}}{(Max \text{ value} - Min \text{ value}) \times Multip.} \times (Meas. \text{ value} - (Min \text{ value} \times Multip.)) \right] + AO1 \text{ con. low limit}$$

E.g. 1 :

Assume that the following values have been assigned;

Input connection : V1(L-N) (phase-neutral voltage of phase 1)

Output connection : 0-5V

Min. value : 100V

Max. value : 200V

Multiplier : 1

Then, when measure is KLEA V1(L-N)=120V, the result will be as follows,

$$AO1-GND = \left[\frac{5-0}{100 \times 1} \times 120 - (100 \times 1) + 0 = 1V \right] \text{ olur (200 - KLEA V1(L-N)=185V the result will be as follows,}$$

$$AO1-GND = \left[\frac{5-0}{100 \times 1} \times 185 - (100 \times 1) + 0 = 4.25V \text{ olur. (200-}$$

E.g. 2 :

Assume that the following have been assigned;

Input connection : P tot.(total active power) Output connection: 4-20mA

Min. value : 600W

Max. value : 1000W

Multiplier : 1

Then, when measure is KLEA P tot. = 732W, the result will be as follows,

$$AO1-GND = \left[\frac{20-4}{(1000-600) \times 1} \times (732 - (600 \times 1)) \right] + 4 = 5.28mA$$

When measure is KLEA V1(L-N)=992W, the result will be as follows,

$$AO1-GND = \left[\frac{20-4}{(200-100) \times 1} \times (992 - (600 \times 1)) \right] + 4 = 19.68mA$$

E.g. 3 :

Assume that the following have been assigned;

Input connection : Q tot.(total reactive power) Output connection: -10 - 10V

Min. value : 1400VAr

Max. value : 1800VAr,

Multiplier : kilo

When measure is KLEA S tot.=1485000VAr, the result will be as follows,

$$AO1-GND = \left[\frac{10 - (-10)}{(1800 - 1400) \times 1000} \times (1485000 - (1400 \times 1000)) \right] + (-10) = -5.75V$$

When measure is KLEA V1(L-N)=1695000VA , the result will be as follows,

$$AO1-GND = \left[\frac{10 - (-10)}{(1800 - 1400) \times 1000} \times (1695000 - (1400 \times 1000)) \right] + (-10) = 4,75V$$

3.2.1.1.6.2 Output 2 Menu

Analog output 2 settings are the same as Output1. Analog output gives output from AO2- GND pins.

3.2.1.1.6.3 Output 3 Menu

Analog output 3 settings are the same as Output1. Analog output gives output from AO3- GND pins

3.2.1.1.6.4 Output 4 Menu

Output 4 Menu Settings ve kullanımı, Output 1 Menu ile aynıdır. Analog Output , AO4-GND üzerinden alınır.

3.2.1.1.7 Communication Menu

KLEA implements ModeBUS over serial line with RTU mode. In this menu, settings related with Modebus RTU are accomplished.

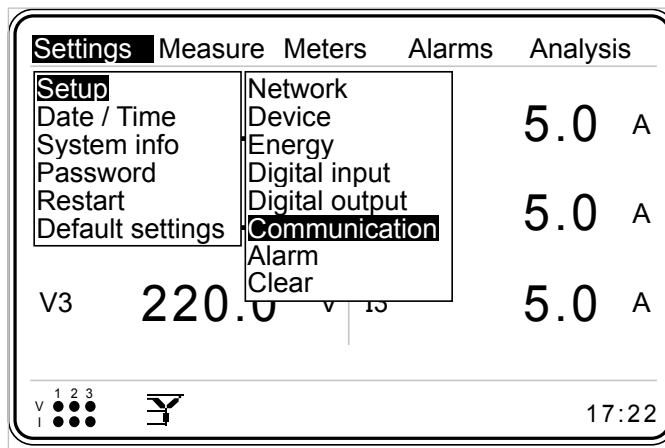

Fig. 3-44 Communication Menu

3.2.1.1.7.1 Baud Rate Menu

Inside Communication menu, press up and down keys to select (highlight) 'Baud rate' menu item. Press OK key and baud rate options will appear on the screen as seen in Figure 3-45. Scroll inside options by pressing up and down keys; press OK key to select the desired value. Available baud rates are: 2400, 4800, 9600, 19200, 38400, 57600 and 115200 bit/sec.

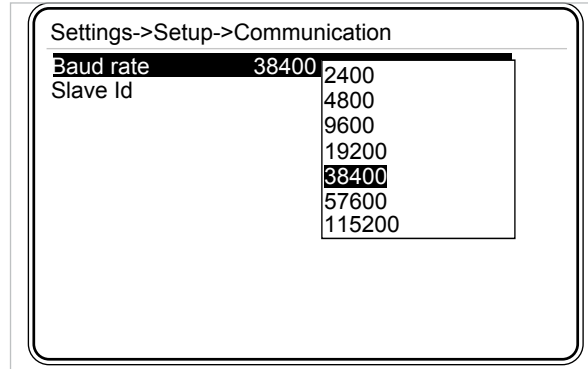

Fig. 3-45 Setting Baud Rate

3.2.1.1.7.2 Slave Id

In this tab, operator can adjust the slave ID. (For Virtual Keyboard Refer to 3.1.4 E.g.)

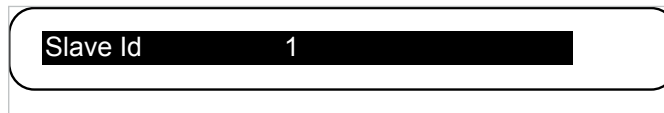

Fig. 3-46 Slave Id

KLEA can operate in an RS-485 network having a maximum quantity of 247 units. As a result, 'Slave Id' can be adjusted between 1 and 247.

3.2.1.1.8 Alarm Menu

Inside 'Setup' menu, when 'Alarm' is selected, press OK key and the options in Figure 3-47 will appear on the screen. Press up and down keys to select the desired option and press OK key to complete the setting.

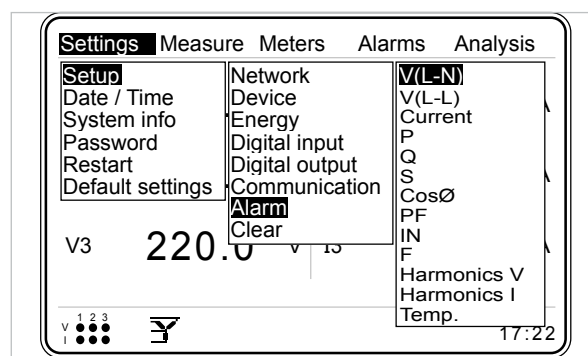

Fig. 3-47 Alarm Menu

3.2.1.1.8.1 V(L-N) Menu

Inside 'Alarm' menu, when V(L-N) is highlighted, press OK key and the following page will appear on the screen.

Settings->Setup->Alarm->V(L-N)		
Alarm relay	Off	
Low limit	0.0	V
High limit	0.0	V
Delay	0	sec
Hysteresis	0.0	%

Fig. 3-48 V(L-N) Menu

Alarm relay :

This setting is merely used to energize or not to energize a relay, when an alarm occurs. For alarm relay setting, following options are available:

Off : In case of V(L-N) alarm, none of the alarm relays is energized

Relay1 : In case of V(L-N) alarm, relay 1 is energized

Relay2 : In case of V(L-N) alarm, relay 2 is energized

Press up and down keys to select the desired option and press OK key to complete the setting.

Alarm relay	Off
-------------	-----

Fig. 3-49 Alarm Relay Setup

In order to adjust Klea to issue V (L-N) alarms, operator should adjust low limit and high limit values as described below.

When V(L-N) of "any" of the three phases exceeds "Low limit" or "High Limit", Klea gives an alarm.

Low Limit:

Low limit value for the V(L-N) alarm. (For Virtual Keyboard Refer to 3.1.4 E.g.). In order to set an alarm for V(L-N), operator should enter a low limit value smaller than the high limit value. When low limit and high limit values are entered to be the same, V(L-N) alarm will be deactivated (no alarm will be set).

High Limit:

High limit value for the V(L-N) alarm. (For Virtual Keyboard Refer to 3.1.4 E.g.). In order to set an alarm for V(L-N), operator should enter a high limit value larger than the low limit value. When low limit and high limit values are entered to be the same, V(L-N) alarm will be deactivated (no alarm will be set).

Delay:

When the related alarm parameter exceeds the “Low limit” or “High Limit” value; before declaring an alarm, Klea waits for “delay time”. Similarly, when the related alarm parameter enters into the limit values, Klea waits for “delay time”, before cancelling the alarm. “Delay” can be adjusted between 0→600 sec. (For Virtual Keyboard Refer to 3.1.4 E.g.).

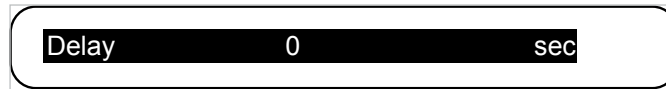

Fig. 3-50 Alarm Time Setting

Hysteresis:

It is the tolerance entered as percentage for high and low limits . Hysteresis can be adjusted between 0→20 (For Virtual Keyboard Refer to 3.1.4 E.g.). Examine following example and Fig. 3-52)

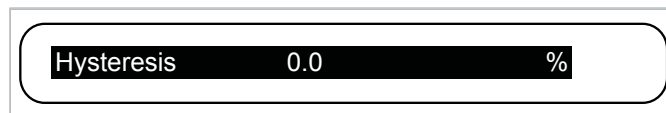

Fig. 3-51 Hysteresis Setting

E.g.

- For the following figure(‘Delay’ is adjusted to be zero);
- At point A, alarm occurs
- At point B, alarm disappears
- At point C, alarm occurs
- At point D, alarm disappears

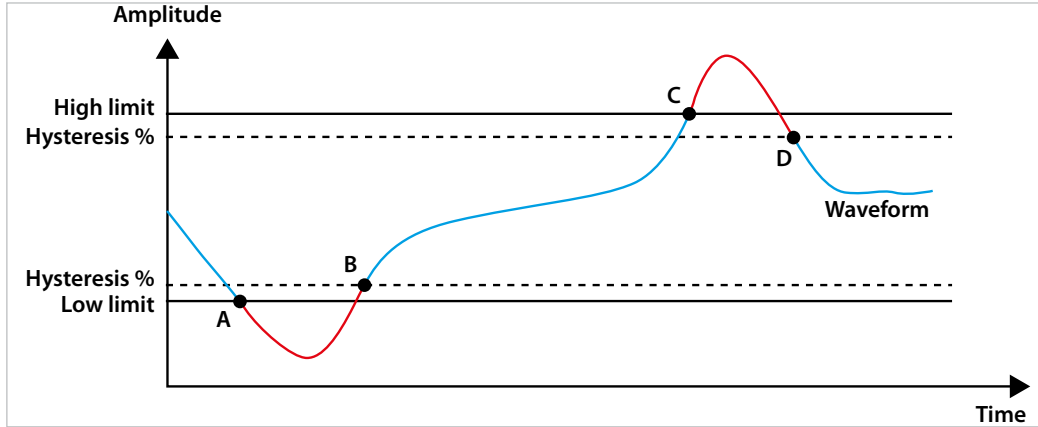

Fig. 3-52 Alarm Example

3.2.1.1.8.2 V(L-L) Menu

Alarm for phase-to-phase voltages is adjusted in this submenu. V(L-L) settings are the same as V(L-N). Low and high limit values can be adjusted between 0↔2600000).

3.2.1.1.8.3 Current Menu

Alarm for current is adjusted in this submenu. Current settings are the same as V(L-N). Low and high limit values can be adjusted between 0↔30000).

3.2.1.1.8.4 P Menu

Alarm for active power is adjusted in this submenu. P settings are the same as V(L-N). Low and high limit values can be adjusted between: -10000000000↔10000000000)

3.2.1.1.8.5 Q Menu

Alarm for reactive power is adjusted in this submenu. Q settings are the same as V(L-N). Low and high limit values can be adjusted between: -10000000000↔10000000000).

3.2.1.1.8.6 S Menu

Alarm for apparent power is adjusted in this submenu. S settings are the same as V(L-N). Low and high limit values can be adjusted between: 0.0↔10000000000).

3.2.1.1.8.7 CosØ Menu

Alarm for cosØ is adjusted in this submenu. cosØ settings are the same as V(L-N). Low and high limit values can be adjusted between: 0↔1).

3.2.1.1.8.8 PF Menu

Alarm for power factor is adjusted in this submenu. Power factor settings are the same as V(L-N). Low and high limit values can be adjusted between: 0↔1.

3.2.1.1.8.9 IN Menu

Alarm for neutral current is adjusted in this submenu. Neutral current settings are the same as V(L-N). Low and high limit values can be adjusted between: 0↔90000

3.2.1.1.8.10 F Menu

Alarm for frequency is adjusted in this submenu. Frequency settings are the same as V(L-N). Low and high limit values can be adjusted between: 35↔70.

3.2.1.1.8.11 Temp. Menu

Alarm for temperature is adjusted in this submenu. Temperature settings are the same as V(L-N). Low and high limit values can be adjusted between: -20↔80.



When the low and high limit values are entered the same, KLEA will not issue an alarm.

Settings->Setup->Alarm->Current		
Alarm relay	Relay1	
Low limit	0.0	A
High limit	0.0	A
Delay	0.0	sec
Hysteresis	0.0	%

Fig. 3-53 Setting for No Alarm



When operator enters a low limit value larger than the high limit, "Invalid limits. Please check." message appears on the screen.

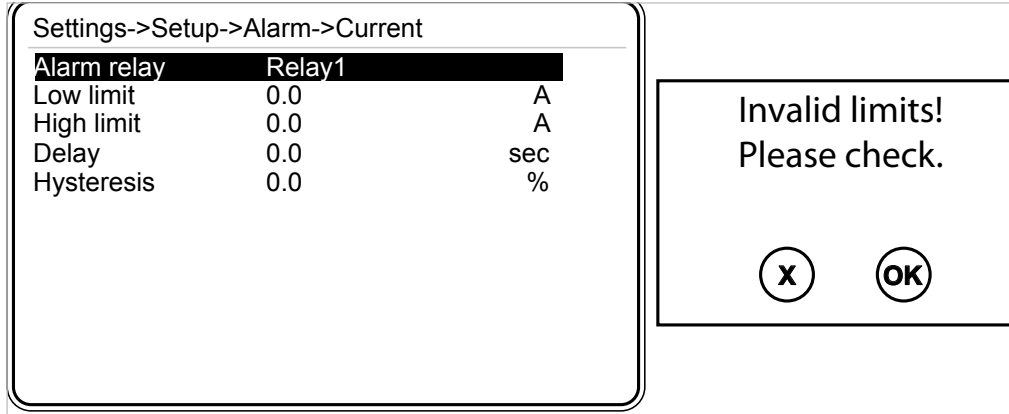

Fig. 3-54 Invalid Limits message

3.2.1.1.8.12 Harmonics V Menu

Inside 'Alarm' menu, when Harmonics V is highlighted, press OK key and the following page will appear on the screen.

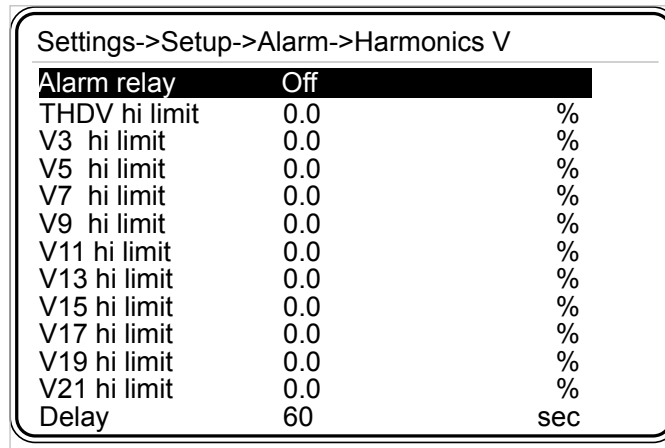

Fig. 3-55 Harmonics Menu

Alarm relay:

Refer to [3.2.1.1.8.1 V\(L-N\) - Menu - Alarm relay setting](#).

THDV High Limit:

High limit value for total harmonic distortion - voltage alarm (For Virtual Keyboard Refer to [3.1.4 E.g.](#)). In order to set an alarm for THDV, operator should enter a high limit value larger than zero. When high limit is entered as zero, THDV alarm will be deactivated (no alarm will be set). It can be adjusted between 0↔100.

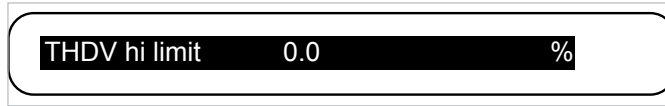

Fig. 3-56 THDV High Limit Setting

V3 --- V21 high limit:

“3,”“5”...“21.”harmonic distortion high limit values are entered. In order to set an alarm for V3, V5 – V21 operator should enter a high limit value larger than zero. When high limit is entered as zero (0.0), V3, V5 – V21 alarm(s) will be deactivated (no alarm will be set). High limits can be adjusted between . 0↔100 For Virtual Keyboard Refer to 3.1.4 E.g.).

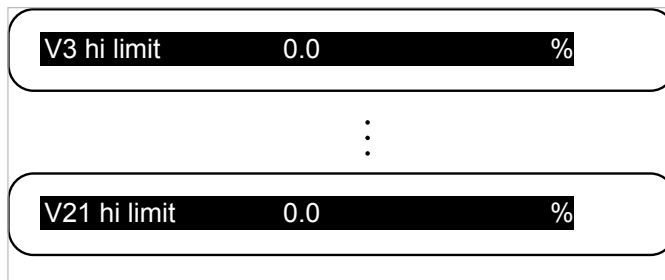

Fig. 3-57 V3 - V21 Harmonic High Limit

Delay:

See 3.2.1.1.8.1 V(L-N) Menu - Delay setting.

3.2.1.1.8.13 Harmonics I Menu

“Harmonics I” settings are the same as the “Harmonics V” alarm settings.

3.2.1.1.9 Clear Menu

In this tab, operator can clear demand values, energy (tariff meter) values and DI (Digital Input) counters. “All” option clears all, namely, demand, energy and DI counter values. When “Clear” is highlighted, press OK key and the following page will appear on the screen.

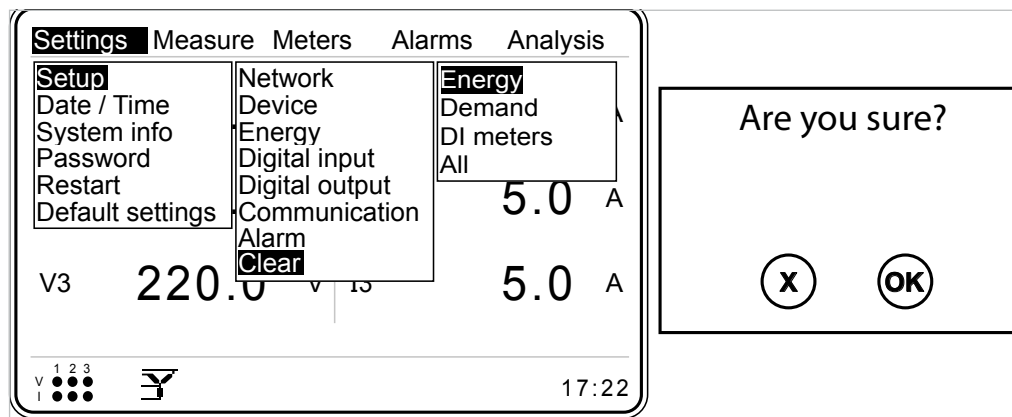

Fig. 3-58 Clear Menu

Scroll inside options by pressing up and down keys; press OK key to clear the desired option. When OK key is pressed, "Are you sure?" message will appear on the screen. Press again OK key to clear the parameter; press X key to exit with no change in the selected parameter.

Assume that "Meters=> Imp. Active=> T1" (Import active power) submenu is as shown below.

Meters->Imp. active		
T1	267500.1	kWh
T1 rate 1	0.0	kWh
T1 rate 2	0.0	kWh
T1 rate 3	0.0	kWh
T2	0.0	kWh

Fig. 3-59 Before Clear

When the clear process is completed, the submenu "Meters->T1->Imp. Active" will be as shown in the Fig. 3-60.

Meters->Imp. active		
T1	0.0	kWh
T1 rate 1	0.0	kWh
T1 rate 2	0.0	kWh
T1 rate 3	0.0	kWh
T2	0.0	kWh

Fig. 3-60 After Clear

After the clear process, for index parameters, a value different than zero may be observed.

This value, is the initial value entered by the operator.

Assume that, initial value of "Setup->Energy->T1 kWh" was entered as 7500 kWh. In this case, after the clear process is completed, "Meters->Imp. active->T1 " value will be 7500kWh. (Refer to Fig. 3.61).

Meters->Imp. active		
T1	7500.0	kWh
T1 rate 1	0.0	kWh
T1 rate 2	0.0	kWh
T1 rate 3	0.0	kWh
T2	0.0	kWh

Fig. 3-61 Initial Value, After Clear Process

3.2.1.2 Date / Time Menu

In the following menu Date / Time setting is made.
 (For date/time setting Refer to 3.1.4 E.g.).

Settings	Measure	Meters	Alarms	Analysis	Settings->Date / Time	
Setup					Time	17 : 22 : 17
Date / Time	0	V I1		5.0 A	Date	07 January 2013
System info						
Password						
Restart	0	V I2		5.0 A		
Default settings						
V3	220.0	V I3		5.0 A		
						17:22

Fig. 3-62 Date / Time Menu

3.2.1.3 System Info Menu

This menu is for information – no setting is accomplished.

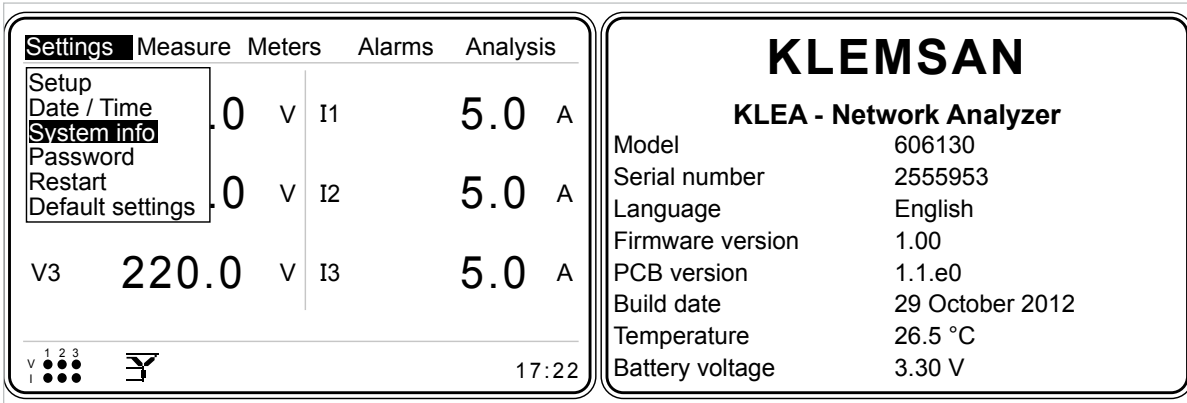

Fig. 3-63 System Info

Temperature and battery voltage values can be reached via RS485.

3.2.1.4 Password Menu

If operator have not entered password; only Date/Time, System Info and Password tabs are active inside settings menu. In order for the remaining tabs to be activated, operator should login via 'Password' tab.

If the entered password is correct, "Login success" message appears on the screen. Otherwise, "Password mismatch" message will be displayed on the screen.

(For Virtual Keyboard Refer to 3.1.4 E.g.).

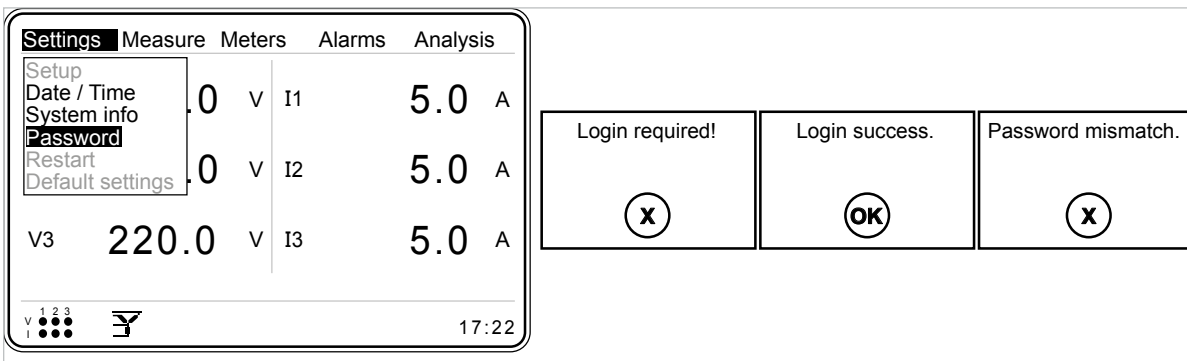

Fig. 3-64 Password

3.2.1.5 Restart Menu

If OK key is pressed on the restart tab, "Are you sure?" message appears on the screen. Press again OK key to restart Klea.

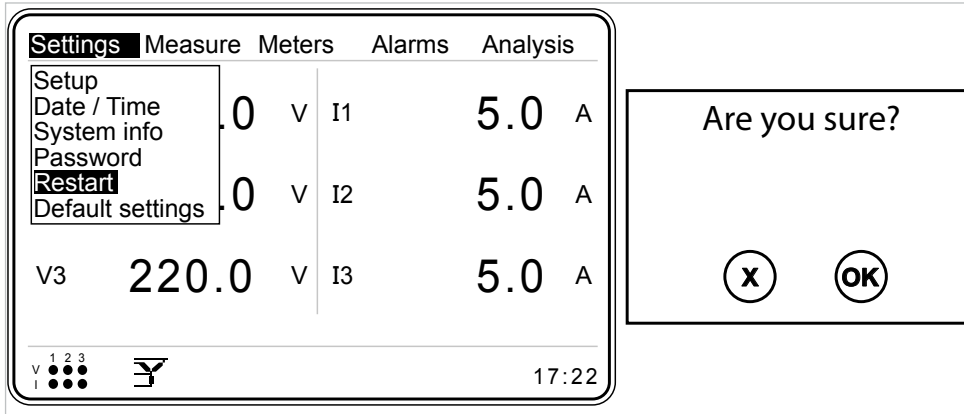

Fig. 3-65 Restart

3.2.1.6 Default Settings

This menu is used to return to factory default settings. All settings except date and time return to the factory defaults.

NOTE: Tariff meter indexes are not assumed to be a setting. As a result, index values will not be cleared via this menu.

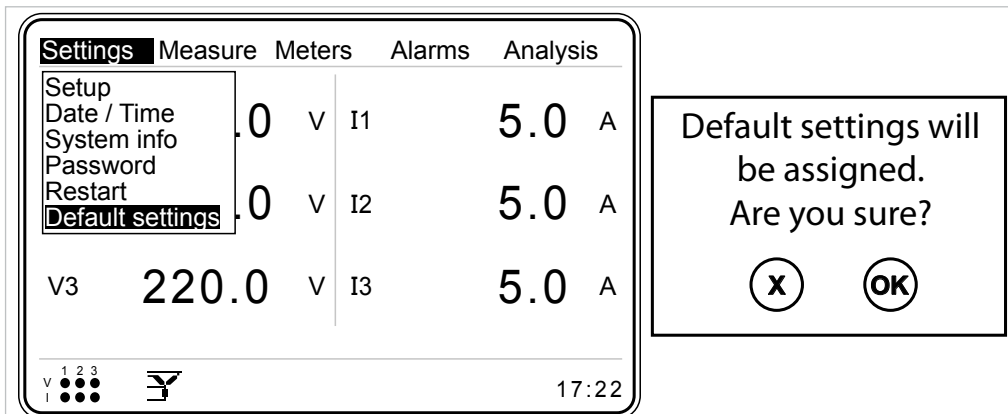

Fig. 3-66 Default Settings Command

3.2.2 Measure Menu

The following submenus are included under the measure menu. Operator can navigate inside measure menu by up and down keys. When the desired menu item is highlighted, press OK key to select. Following menu items are available:

- Instantaneous
- Demand
- Phasor diagram
- Signals
- Harmonics

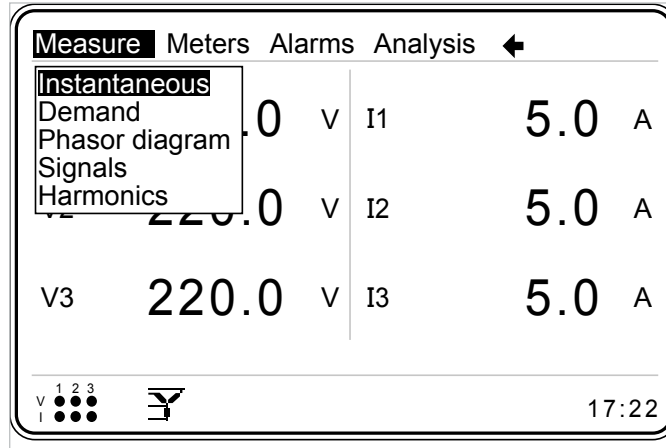

Fig. 3-67 Measure Menu

3.2.2.1 Instantaneous Menu

This menu includes instantaneous values. If OK is pressed on this tab, the following page appears on the screen. Operator can scroll inside Instantaneous values by pressing right and left keys.

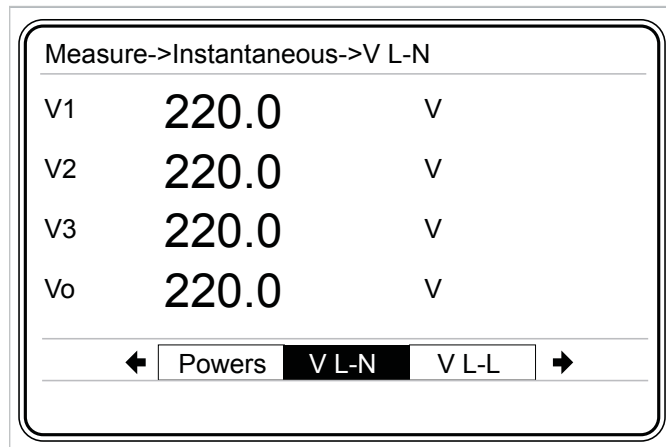

Fig. 3-68 Instantaneous Menu

- Line-to-neutral V (L-N) voltage for each phase and their average
- Line-to-line V(L-L) voltage for each phase and their average
- Phase currents (I) and their sum
- Neutral current (IN)
- CosØ for each phase and CosØ of system
- Power factor (PF) for each phase and power factor (PF) of system
- Active power (P) for each phase and their sum
- Reactive power (Q) for each phase and their sum
- Apparent power (S) for each phase and their sum
- Frequency (F) for each phase
- THDV values for each phase and their sum
- THDI values for each phase and their sum
- Total powers



If "3phase 3 wire" is selected as connection type, "VL-N" title in instantaneous menu will be replaced with "V".

In Measure-Instantaneous-P(active power) page;
 if active power value(of any phase) is positive (a "+" sign after the number), that phase consumes power,
 if active power value(of any phase) is negative (a "-" sign after the number), that phase generates power.

The above phenomenon also applies for total P (active power) value.



When Klea is mounted on a panel which consumes power, the values in Measure-Instantaneous-P page should be positive(+). When Klea is mounted on a panel which generates power, the values in Measure-Instantaneous-P page should be negative(-).

Otherwise, K-L leads of the current should be cross connected.

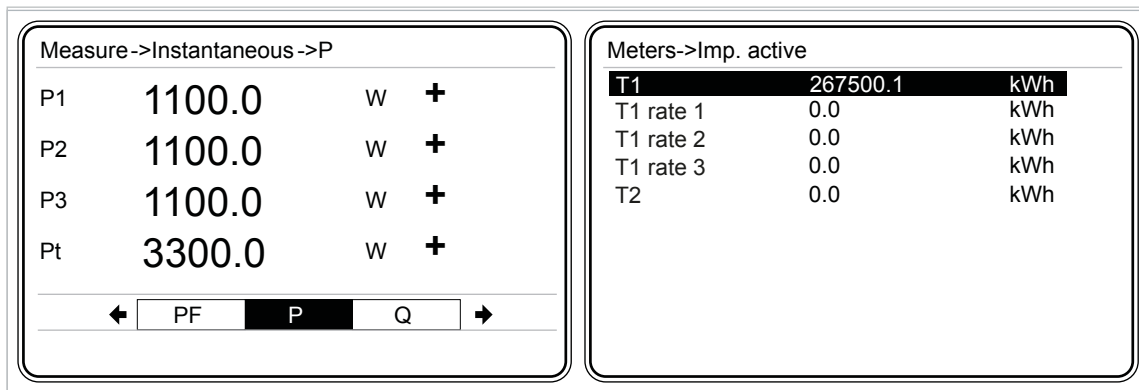

Fig. 3-69 Connecting the K-L ends of Current Correctly

3.2.2.2 Demand Menu

During demand period, Klea, calculates averages for current, active, reactive and apparent powers for three phases. Maximum of these averages are stored as the demand value with a corresponding time stamp.

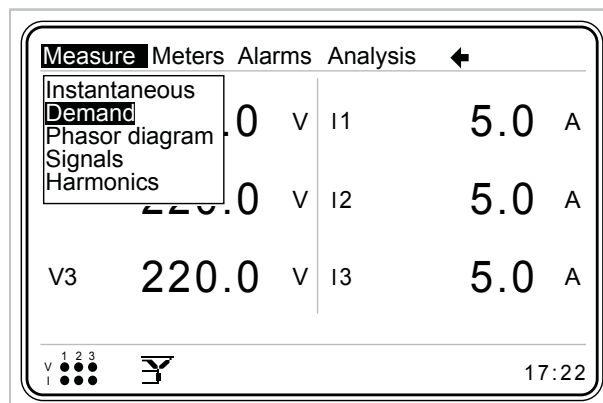

Fig. 3-70 Demand Menu

E.g.:

The following graph shows the averages of current signals that are calculated/measured during the 15 minutes (demand period=15) and demand value.

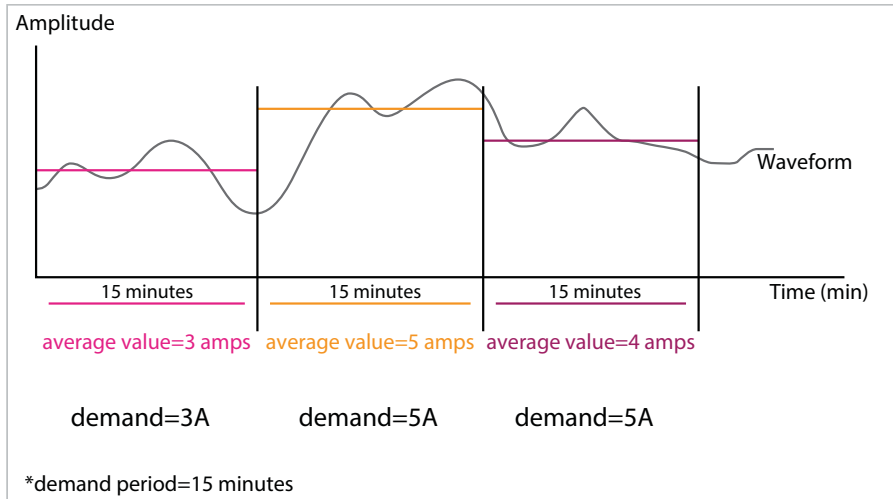

Fig. 3-71 Demand Example

3.2.2.2.1 Current Month Menu

This menu displays demand values of current, active, reactive and apparent power of three phases and their totals for the current (present) month.

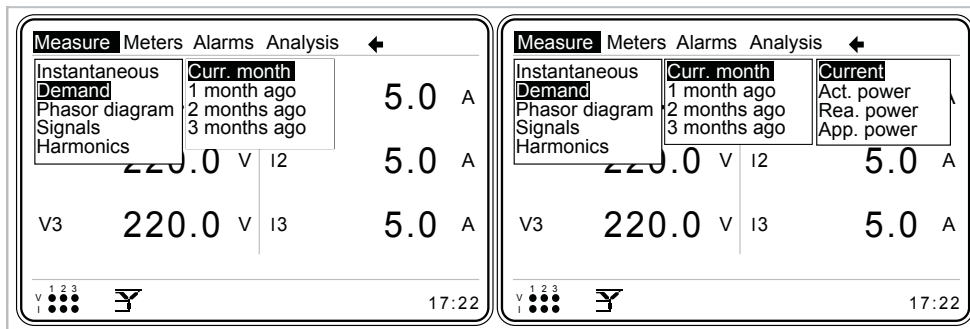

Fig. 3-72 Current Month Menu

“Start of day” and “start of month” settings are adjusted in “Settings->Setup->Energy” menu. “Start of day” and “start of month” are important for “Curr. Month”, “1 month ago”, “2 months ago” and “3 months ago” submenus.

E.g.:

Assume that start of day is "8", and start of month is "26"; When time is 08.00 on 26th day of the month;

"Current month" values will be assigned as	→	"1 month ago" values,
"1 month ago" values will be assigned as	→	"2 months ago" values,
"2 months ago" values will be assigned as	→	"3 months ago" values.

And new values will be saved in "current month" menu.

Settings->Setup->Energy		
T1_1 start time	8	hr
T1_2 start time	16	hr
T1_3 start time	0	hr
Start of day	8	hr
Start of month	1	
T1 kWh	1000.0	kWh
T1 kWh E	1000.0	kWh
T1 kVARh Imp. I.	1000.0	kVARh
T1 kVARh Imp. C.	1000.0	kVARh
T1 kVARh Exp. I.	1000.0	kVARh
T1 kVARh Exp. C.	1000.0	kVARh
T2 kWh	1000.0	kWh

Fig. 3-73 Example of Current Month Menu

3.2.2.2.1.1 Current Menu

This menu shows demand values of currents of each phase and the demand value for the sum of phase currents. Date and time information for demand values can be seen on the screen.

Measure Meters Alarms Analysis ←			Measure->Demand->Curr month->Current		
Instantaneous	Curr. month	Current	Phase1	5.0	A
Demand	1 month ago	Act. power		02:44:59 - 10/10/12	
Phasor diagram	2 month ago	Rea. power	Phase2	5.1	A
Signals	3 month ago	App. power		13:29:59 - 11/10/12	
Harmonics			Phase3	4.9	A
V1	220.0 V	I2		14:29:59 - 09/10/12	
V3	220.0 V	I3	Toplam	15.6	A
				09:14:59 - 12/10/12	
17:22					

Fig. 3-74 Current Menu

E.g.:

Assume that demand period is entered as 15 minutes. Also assume that the current (present) month's 'current demand' and date are: Phase1 5.0 A 02:44:59 - 10/10/12.

This means: On October 10, 2012, demand value of phase1 current in the time interval 02:29:59 – 02:44:59, is 5.0 A.



In order for KLEA to keep demand values for “1 month ago”, “2 months ago” and “3 months ago”; demand period should be set as 1, 2, 3, 4, 5, 6, 10, 12, 15, 20, 30 or 60 min (common divisors of 60).

Otherwise, “1 month ago”, “2 months ago” and “3 months ago” demand values will not be stored.

E.g.:

When the system clock is 15:07:00, assume that demand period is adjusted as 15 minutes. Sequentially, demand periods will be as follows:

05:07:00 - 15:14:59 = The 1st demand period

15:14:59 - 15:29:59 = The 2nd demand period

15:29:59 - 15:44:59 = The 3rd demand period

15:44:59 - 15:59:59 = The 4th demand period

15:59:59 - 16:14:59 = The 5th demand period

3.2.2.2.1.2 Active power Menu

The demand values for active power are as explained in the “Demand->Current Month->Current” submenu.

3.2.2.2.1.3 Reactive power menu

The demand values on the reactive power are as explained in the “Demand->Current Month->Current” submenu.

3.2.2.2.1.4 Apparent power menu

The demand values on the apparent power are as explained in the “Demand->Current Month->Current” submenu.

3.2.2.2.2 1 month Ago Menu

The demand values on the 1 month ago menu are as explained in the “Demand->Current Month” submenu.

3.2.2.2.3 2 Months Ago Menu

The demand values on the 2 months ago menu are as explained in the "Demand->Current Month" submenu.

3.2.2.2.4 3 Months Ago Menu

The demand values on the 3 months ago menu are as explained in the "Demand->Current Month" submenu.

3.2.2.3 Phasor Diagram Menu

In phasor diagram menu page, at the right of the phasor diagram, following information is listed:

- phase voltages (V1, V2, V3)
- phase currents (I1, I2, I3)
- V1-V2, V2-V3 and V3-V1 phase difference angles
- V1-I1, V2-I2 and V3-I3 phase difference angles

Within the phasor diagram, currents are drawn with gray lines, and voltages are drawn with black lines.

Within the phasor diagram, same size circles have been added to the ends of lines belonging to the same phase. Thus, it will be easy to follow currents and voltages of a phase.

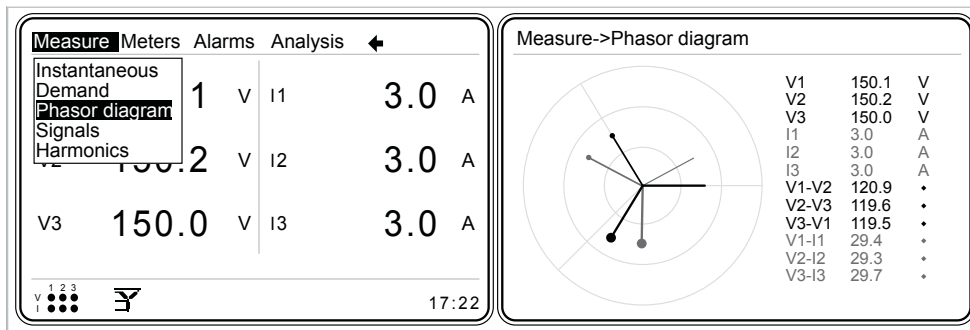

Fig. 3-75 Phasor Diagram Menu

3.2.2.4 Signals Menu

In this menu, current and voltage waveforms are shown. At the right hand side of the waveforms, following information is listed:

- Voltage and current values of phases
- Instantaneous frequency value
- Phase difference between current and voltage

Current signal is in gray, and voltage is in black color. Operator can scroll inside signals menu by pressing left and right keys.

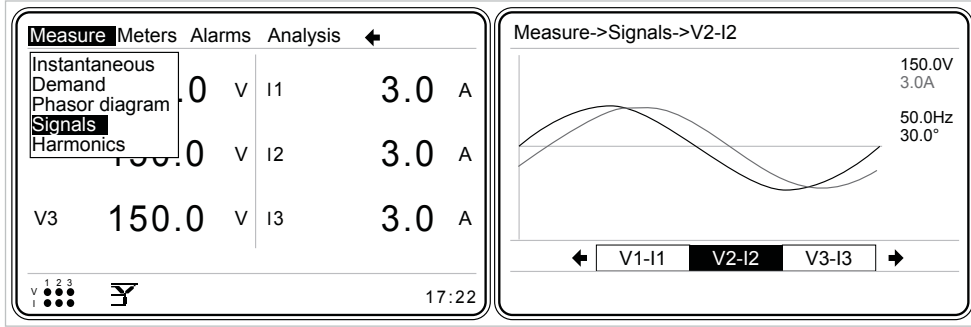

Fig. 3-76 Signals Menu

3.2.2.5 Harmonics Menu

KLEA measures/calculates current and voltage harmonics up to 51st harmonic. Current and voltage harmonics can be monitored in table and in graph format.

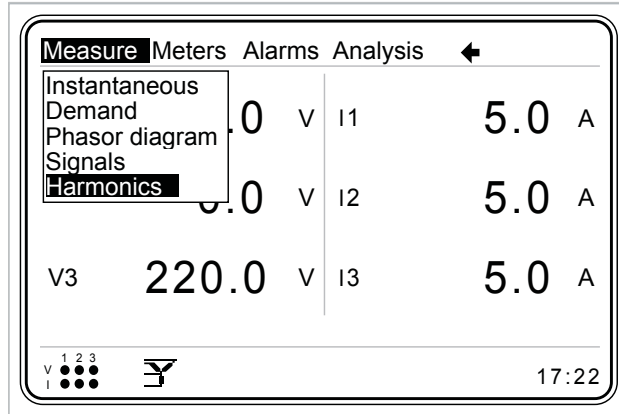

Fig. 3-77 Harmonics Menu

3.2.2.5.1 Table Menu

Current and voltage harmonics of each phase are displayed in a table format (Refer to Fig. 3-78). Operator can scroll inside table menu by pressing right and left keys. There are 6 table pages: V1, V2, V3, I1, I2, I3.

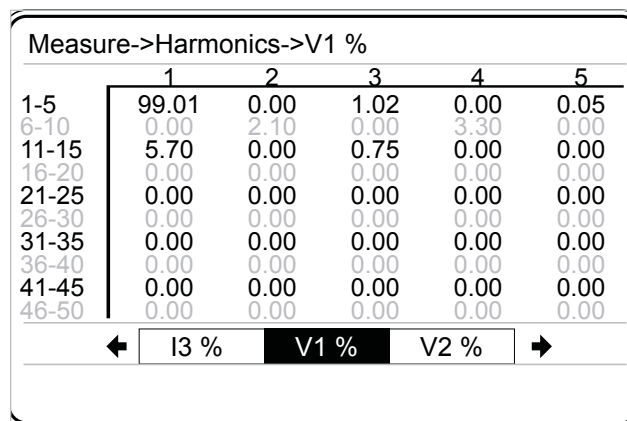

Fig. 3-78 Harmonics in Table Format

3.2.2.5.2 Graph Menu

Current and voltage harmonics of each phase are displayed graphically (Refer to Fig. 3-78). Operator can scroll inside graph menu by pressing right and left keys. There are 6 graph pages: V1, V2, V3, I1, I2, I3.

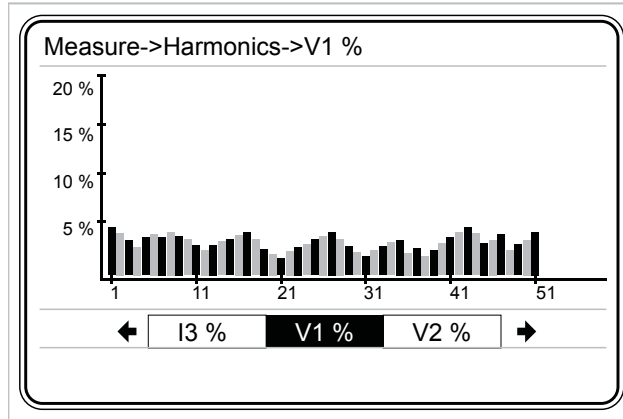

Fig. 3-79 Harmonics in Graphical Format

3.2.3 Meters Menu

In this menu, the energy values of Tariff 1 and Tariff 2 meters are displayed:

- Imp. active
- Exp. active
- Reactive R1
- Reactive R2
- Reactive R3
- Reactive R4
- Digital input
- Other



When an energy meter reaches the value "50000000.0 Mega", it will start to count from "0.0".

3.2.3.1 Imp. Active Menu

Imp. active meter consist of "T1", "T1 Rate1", "T1 Rate2", "T1 Rate3" and "T2" energy values.

Meters	Alarms	Analysis
Imp. active		
Exp. active	0 V I1	0.0 A
Reactive R1		
Reactive R2		
Reactive R3	0 V I2	0.0 A
Reactive R4		
Digital input		
Other	0.0 V I3	0.0 A

Fig. 3-80 Imp. Active Menu

3.2.3.1.1 T1 Tab.

Import active energy values that belongs T1 are displayed as seen in the following figure:

Meters->Imp. active		
T1	302500.0	kWh
T1 rate1	99250.0	kWh
T1 rate2	98350.0	kWh
T1 rate3	104900.0	kWh
T2	3506.0	kWh

Fig. 3-81 Imp. Active Energy Page

3.2.3.1.2 T1 Rate1 Tab.

T1 Rate1 meter that belongs to T1, counts between T1_1 start time and T1_2 start time. Refer to: 3.2.1.1.3.1 and 3.2.1.1.3.2 for "T1_1 start time" and "T1_2 start time" settings.

Meters->Imp. active		
T1	302500.0	kWh
T1 rate1	99250.0	kWh
T1 rate2	98350.0	kWh
T1 rate3	104900.0	kWh
T2	3506.0	kWh

Fig. 3-82 T1 rate1 import active energy

3.2.3.1.3 T1 Rate2 Tab.

T1 Rate2 meter that belongs to T1, counts between T1_2 start time and T1_3 start time. Refer to: 3.2.1.1.3.2 and 3.2.1.1.3.3 for "T1_2 start time" and "T1_3 start time" settings.

Meters->Imp. active		
T1	302500.0	kWh
T1 rate1	99250.0	kWh
T1 rate2	98350.0	kWh
T1 rate3	104900.0	kWh
T2	3506.0	kWh

Fig. 3-83 T1 rate2 import active energy

3.2.3.1.4 T1 Rate3 Tab.

T1 Rate3 meter that belongs to T1, counts between T1_3 start time and T1_1 start time. Refer to: 3.2.1.1.3.3 and 3.2.1.1.3.1 for "T1_3 start time" and "T1_1 start time" settings.

Meters->Imp. active		
T1	302500.0	kWh
T1 rate1	99250.0	kWh
T1 rate2	98350.0	kWh
T1 rate3	104900.0	kWh
T2	3506.0	kWh

Fig. 3-84 T1 rate3 import active energy

3.2.3.1.5 T2 Tab.

Import active energy values that belongs T2 are displayed as seen in the following figure:

Meters->Imp. active		
T1	302500.0	kWh
T1 rate1	99250.0	kWh
T1 rate2	98350.0	kWh
T1 rate3	104900.0	kWh
T2	3506.0	kWh

Fig. 3-85 Tariff 2 import active energy



While Tariff 2 meter is active; Tariff 1, T1 rate1, T1 rate2, T1 rate3 meters are not active. (mutually exclusive).



In order for Tariff 2 to be active;
 1-) "T2" mode should be selected in "digital input1" and/or "digital input2" menu,
 2-) DI and GND pins of the selected input should be short-circuited.
 (Refer to 3.2.1.1.4 Digital input)



If "Tariff 2 mode is "NOT" SELECTED in the digital input menu, even though the related digital input pins are short-circuited, Tariff 2 will not be active - Tariff meter continues to operate.

3.2.3.2 Digital Input Menu

In this menu, counters belonging to digital inputs are displayed. Refer to 3.2.1.1.4 Digital input to adjust a digital input as a counter.

When DI1 and GND pins are short-circuited for at least delay (Refer to 3.2.1.1.4.1.2 Delay) time, "digital input1 counter" value increments by "1".

When DI2 and GND pins are short-circuited for at least delay (Refer to 3.2.1.1.4.1.2 Delay) time, "digital input2 counter" value increments by "1".

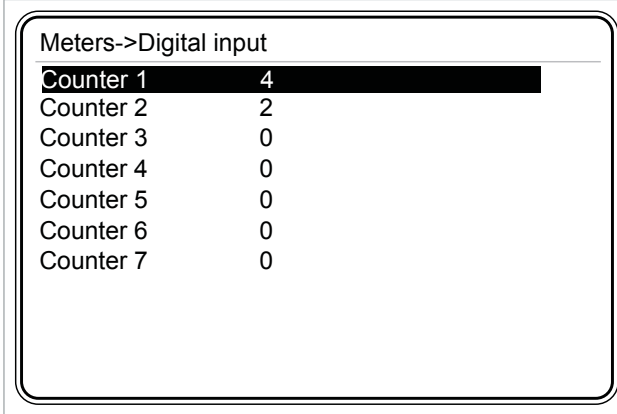

Meters->Digital input	
Counter 1	4
Counter 2	2
Counter 3	0
Counter 4	0
Counter 5	0
Counter 6	0
Counter 7	0

Fig. 3-86 Digital Input Menu(Dijital IO opsiyonlu model)



KLEA base model has 2; optional digital IO model has 7 counters.

3.2.3.3 Others Menu

In this menu, consist of on hour counter, run hour counter and power interruption counter. Only run hour counter can be deleted by users.

3.2.4 Alarms Menu

In this menu, alarms can be monitored. Alarms menu consists of 'Phase1', 'Phase2', 'Phase3' and 'Other' submenus.

In Klea ModeBUS table, 50 alarm statuses can be saved (Refer to Table 4.3).

If the number of alarm statuses exceeds 50; 51st alarm is overwritten on the first alarm.

An alarm status consists of the below information:

Alarm Time Stamp:

Alarm time, 32 bit integer

Alarm Definition:

Alarm flag bit number . Refer to the example below

Alarm State:

Alarm ON or alarm OFF state. Alarm ON and alarm OFF conditions are both considered as records. As a result, both conditions are saved in ModeBUS table as different alarm statuses.

1 -> Alarm ON 0 -> Alarm OFF

Alarm Value:

Value of the related alarm parameter

E.g.:

Assume that, 100 VAC is assigned as low limit for V(L-N) (for phase1, phase2 and phase3 V L-N voltages) and again assume that phase3 voltage falls below 100VAC in the system. In such a case,

Alarm Definition; is the bitwise index number inside the alarm flags [\(4.5.1.1 Alarm flags](#) variable. That is, for the above situation, "alarm definition value" will be 3.

Shortly, alarm definition value can be used as an index in alarm flag variable to reach the explanation for that alarm. Besides, this way, operator will have the opportunity to match the alarm with the alarm flag .

Alarms		Analysis ←	
Phase 1	0	V	I1
Phase 2			5.0 A
Phase 3			
Other			
V2	220.0	V	I2
			5.0 A
V3	220.0	V	I3
			5.0 A

1 2 3
 V I ● ● ●

17:22

Fig. 3-87 Alarms Menu

3.2.4.1 Phase1 Menu

In Phase1 menu, phase1 alarm statuses are displayed.

“Normal” → No alarm

“Alarm” → Alarm

Alarms->Phase1	
V	Alarm
I	Normal
P	Normal
Q	Normal
S	Normal
CosØ	Normal
PF	Normal
V harmonics	Normal
THDV	Normal
I harmonics	Normal
THDI	Normal
F	Normal

Fig. 3-88 Phase1 Menu

In Phase1 menu, following alarm statuses are monitored.

- V (phase-neutral voltage)
- I (current)
- P (active power)
- Q (reactive power)
- S (apparent power)
- cos Ø
- PF (power factor)
- V harmonics (any of 3., 5., - 21. harmonic alarm statuses ORed)
- THDV (total harmonic distortion in voltage)
- I harmonics (any of 3., 5., - 21. harmonic alarm statuses ORed)
- THDI (total harmonic distortion in current)

3.2.4.2 Phase2 Menu

“Phase2” menu consists of the same items as “Phase1” menu. Please refer to 3.2.4.1 Phase1 menu for details.

3.2.4.3 Phase3 Menu

“Phase3” menu consists of the same items as “Phase1” menu. Please refer to 3.2.4.1 Phase1 menu for details.

3.2.4.4 Other Menu

In “Other” menu, explanations are the same as in Phase1 menu.

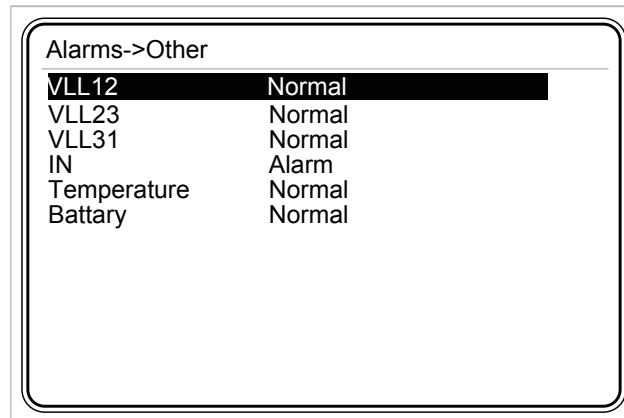

Alarms->Other	
VLL12	Normal
VLL23	Normal
VLL31	Normal
IN	Alarm
Temperature	Normal
Battery	Normal

Fig. 3-89 Other Menu

In “Other” menu, following alarm statuses are monitored:

- VLL12 (phase1-phase2 voltage)
- VLL23 (phase2-phase3 voltage)
- VLL31 (phase3-phase1 voltage)
- IN (neutral current)
- Temperature
- Battery

When the battery voltage falls below 1.9 V value, Klea issues Battery alarm. When Klea issues battery alarm, contact your local authorized dealer (or the nearest authorized dealer).

3.2.5 Analysis Menu

It consists of submenus shown in Fig. 3-90. Analysis menu parameters can also be reached from ModeBUS (Refer to 4.5.3 Archive Records).

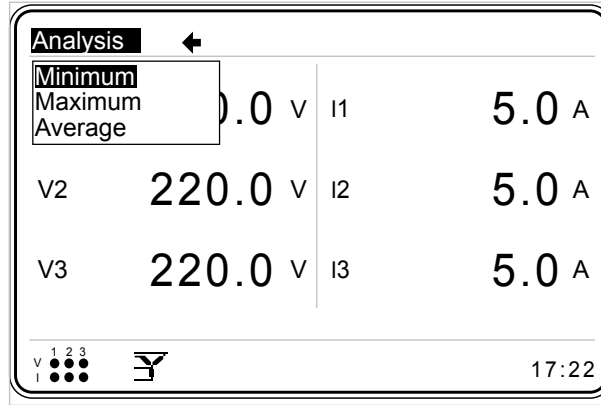

Fig. 3-90 Analysis Menu



Analysis menu parameters are not stored in permanent memory. As a result, all of analysis menu parameters will be cleared when Klea is turned-off.

3.2.5.1 Minimum Menu

It consists of hourly, daily and monthly submenus.

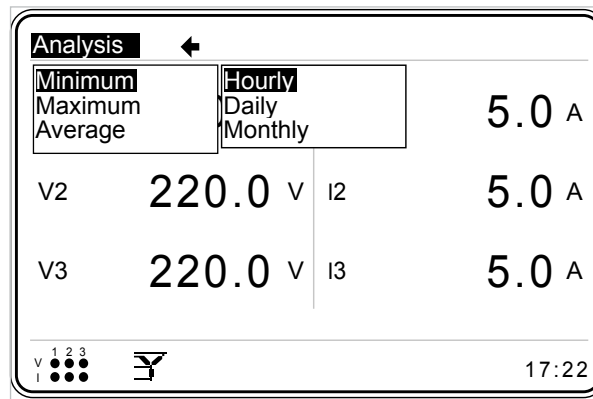

Fig. 3-91 Minimum Menu

3.2.5.1.1 Hourly Menu

This menu displays the minimum “instantaneous” values measured/calculated from the beginning of current hour up to present time.

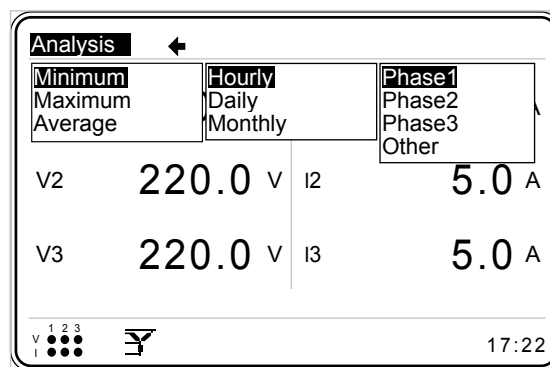

Fig. 3-92 Hourly Menu

3.2.5.1.1.1 Phase1 Menu

Voltage(V), current(I), active power(P), reactive power(Q), apparent power(S), $\cos \emptyset$, power factor(PF), and frequency(F) values are displayed.

3.2.5.1.1.2 Phase2 Menu

Voltage(V), current(I), active power(P), reactive power(Q), apparent power(S), $\cos \emptyset$, power factor(PF), and frequency(F) values are displayed.

3.2.5.1.1.3 Phase3 Menu

Voltage(V), current(I), active power(P), reactive power(Q), apparent power(S), $\cos \emptyset$, power factor(PF), and frequency(F) values are displayed.

3.2.5.1.1.4 Other

VLL12(phase1-phase2 voltage), VLL23(phase2- phase3 voltage), VLL31(phase3-phase1 voltage).

3.2.5.1.2 Daily Menu

This menu displays the minimum instantaneous values measured/calculated from start of day (Refer to 3.2.1.1.3.4) up to present time. Its submenus are the same as "Hourly menu".

3.2.5.1.3 Monthly Menu

This menu displays the minimum instantaneous values measured/calculated from start of month (Refer to 3.2.1.1.3.5) and start of day (Refer to 3.2.1.1.3.4), up to present time. Its submenus are the same as "Hourly menu".

3.2.5.2 Maximum Menu

Submenus and explanations of "Maximum" menu are the same as "Minimum" menu. The values measured in the "Maximum" menu are also "instantaneous" maximum values.

3.2.5.3 Average Menu

Submenus and explanations of "Maximum" menu are the same as "Minimum" menu. In "Average" menu, hourly, daily and monthly average values are displayed.

A decorative graphic consisting of a grid of interconnected circles in orange and dark blue, with some circles having white outlines. The circles are arranged in a pattern that resembles a molecular structure or a network. The graphic is positioned on the left side of the page, partially overlapping the KLEA logo and extending towards the bottom.

**SECTION 4
MODBUS
PROTOCOL**

BÖLÜM 4 MODBUS PROTOCOL

4.1 RS485 Wiring Diagram

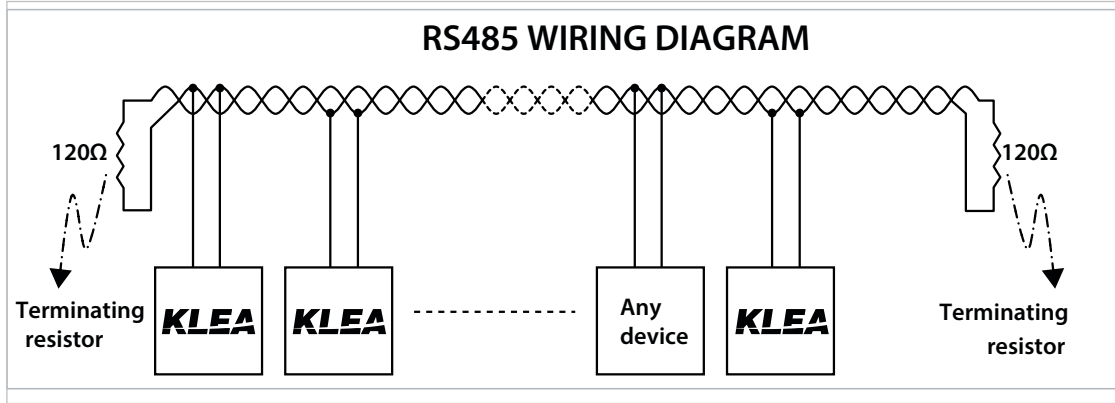

Fig. 4-1 RS485 Wiring Diagram

4.2 Computer Connection

KLEA can communicate with PCs via USB-RS85 or RS232-RS485 converters.

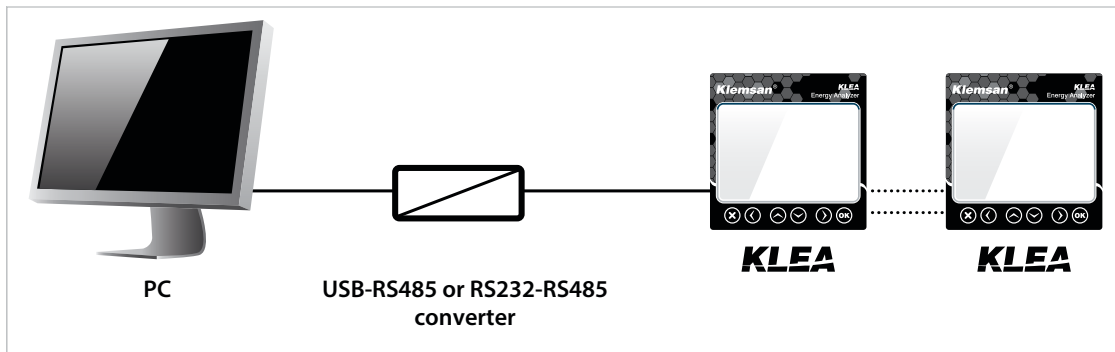

Fig. 4-2 Connection of KLEA to a PC

4.3 Message Format and Data Types of ModeBUS-RTU Protocol

KLEA implements modebus RTU protocol. Modebus RTU message format is as follows

Tablo 4-1 Message Format

Start	Address	Function	Data	CRC	End
≥ 3.5 byte	1 byte	1 byte	0-252 byte	2 byte	≥ 3.5 byte

There should be a time gap, which is at least 3.5 characters wide, between RTU messages.

For instance, when client device requests any information, server device should reply after at least a 3.5 character wide time gap. Following the response of the server, client device should wait 3.5 characters long period, before requesting information again.

Data types used in KLEA are as follows

Tablo 4-2 int (32 bit) data type

b31 (Bit 31)	-----	b0 (Bit 0)
MSB (Most Significant Bit)	-----	LSB (Least Significant Bit)

int:

32-bit integer value. Byte order starts from the lowest byte address as b0, b1, b2 and so on.

float:

It is a 32-bit floating-point number in IEEE 754 standard.

string:

Character array in ASCII standard. It is only used for Klea device name and Klea configuration name variables.

4.4 Implemented functions for ModeBUS-RTU Protocol

Tablo 4-3 Implemented functions for ModeBUS RTU Protocol

Function Name	Function Code
Read Holding Registers	03H (decimal value 3)
Write Single Register	06H (decimal value 6)
Write Multiple Registers	10H (decimal value 16)
Read file record	14H (decimal value 20)

4.5 Data and Setting Parameters for KLEA

4.5.1 Measured and Calculated Data



Calculated and measured data are "read-only" values.

Operator/programmer can reach all measured and calculated data via ModeBUS RTU protocol. Starting address for measured and calculated data is 0.

E.g.:

Three phase average voltage is read via the 0th and 1th registers (16 bits + 16 bits = 32 bit).

PC (or PLC) Request		KLEA Response	
Slave ID	01h	Slave ID	01h
Function code	03h	Function code	03h
Register address – high	00h	Byte counts	04h
Register address – low	00h	Register value - high (0)	43h
Number of registers– high	00h	Register value - low (0)	5Dh
Number of registers – low	02h	Register value - high (1)	36h
CRC high	C4h	Register value - low (1)	E0h
CRC low	0Bh	CRC high	68h
		CRC low	4Dh

The “Byte counts” information of KLEA response is two times “Number of registers” value of “PC request” (1 register = 2 bytes).

Register value high(0) and low(0) together with register value high(1) and low(1) constitute a 32-bit value. This value should be converted (typecasted) to a flo t value. The flo t value of the mentioned 32-bit variable is 221.2143555

Tablo 4-4 Read-only Data

Address	Parameter	Description	R/W	Unit	Data Type
0	V avg.	Average voltage of three phases	RO	V	32 bit flo t
2	I tot.	Total current of three phases	RO	A	32 bit flo t
4	P tot.	Total active power of three phases	RO	V	32 bit flo t
6	Q tot.	Total reactive power of three phases	RO	VAr	32 bit flo t
8	S tot.	Total apparent power of three phases	RO	VA	32 bit flo t
10	CosØ avg.	Average CosØ of three phases	RO	-	32 bit flo t
12	PF avg.	Average PF of three phases	RO	-	32 bit flo t
14	VLL1	Voltage V1-2	RO	V	32 bit flo t
16	VLL2	Voltage V2-3	RO	V	32 bit flo t
18	VLL3	Voltage V3-1	RO	V	32 bit flo t
20	VLL avg.	Average of line to line voltage of three phases	RO	V	32 bit flo t
22	I nötr	Neutral current	RO	A	32 bit flo t
24	THDV tot.	Total har. distortion of voltage for three	RO	%	32 bit flo t
26	THDI tot.	Total har. distortion of voltage for three	RO	%	32 bit flo t

Address	Parameter	Description	R/W	Unit	Data Type
Phase 1					
28	L1 V	Phase1 voltage	RO	V	32 bit flo t
30	L1 I	Phase1 current	RO	A	32 bit flo t
32	L1 P	Phase1 active power	RO	W	32 bit flo t
34	L1 Q	Phase1 reactive power	RO	VAr	32 bit flo t
36	L1 S	Phase1 apparent power	RO	VA	32 bit flo t
38	L1 CosØ	Phase1 CosØ	RO	-	32 bit flo t
40	L1 PF	Phase1 power factor	RO	-	32 bit flo t
42	L1 F	Phase1 frequency	RO	Hz	32 bit flo t
44	L1 THDV	Phase1 total har. distortion of voltage	RO	%	32 bit flo t
46	L1 THDI	Phase1 total har. distortion of current	RO	%	32 bit flo t
48	L1 V Harmonics1	Phase1 voltage first harmonic	RO	%	32 bit flo t
50	L1 V Harmonics3	Phase1 voltage third harmonic	RO	%	32 bit flo t
52	L1 V Harmonics5	Phase1 voltage 5th harmonic	RO	%	32 bit flo t
54	L1 V Harmonics7	Phase1 voltage 7th harmonic	RO	%	32 bit flo t
56	L1 V Harmonics9	Phase1 voltage 9th harmonic	RO	%	32 bit flo t
58	L1 V Harmonics11	Phase1 voltage 11th harmonic	RO	%	32 bit flo t
60	L1 V Harmonics13	Phase1 voltage 13th harmonic	RO	%	32 bit flo t
62	L1 V Harmonics15	Phase1 voltage 15th harmonic	RO	%	32 bit flo t
64	L1 V Harmonics17	Phase1 voltage 17th harmonic	RO	%	32 bit flo t
66	L1 V Harmonics19	Phase1 voltage 19th harmonic	RO	%	32 bit flo t
68	L1 V Harmonics21	Phase1 voltage 21th harmonic	RO	%	32 bit flo t
70	L1 V Harmonics23	Phase1 voltage 23th harmonic	RO	%	32 bit flo t
72	L1 V Harmonics25	Phase1 voltage 25th harmonic	RO	%	32 bit flo t
74	L1 V Harmonics27	Phase1 voltage 27th harmonic	RO	%	32 bit flo t
76	L1 V Harmonics29	Phase1 voltage 29th harmonic	RO	%	32 bit flo t
78	L1 V Harmonics31	Phase1 voltage 31th harmonic	RO	%	32 bit flo t
80	L1 V Harmonics33	Phase1 voltage 33th harmonic	RO	%	32 bit flo t
82	L1 V Harmonics35	Phase1 voltage 35th harmonic	RO	%	32 bit flo t
84	L1 V Harmonics37	Phase1 voltage 37th harmonic	RO	%	32 bit flo t
86	L1 V Harmonics39	Phase1 voltage 39th harmonic	RO	%	32 bit flo t
88	L1 V Harmonics41	Phase1 voltage 41th harmonic	RO	%	32 bit flo t
90	L1 V Harmonics43	Phase1 voltage 43th harmonic	RO	%	32 bit flo t
92	L1 V Harmonics45	Phase1 voltage 45th harmonic	RO	%	32 bit flo t
94	L1 V Harmonics47	Phase1 voltage 47th harmonic	RO	%	32 bit flo t
96	L1 V Harmonics49	Phase1 voltage 49th harmonic	RO	%	32 bit flo t
98	L1 V Harmonics51	Phase1 voltage 51th harmonic	RO	%	32 bit flo t
100	L1 I Harmonics1	Phase1 current first harmonic	RO	%	32 bit flo t
102	L1 I Harmonics3	Phase1 current third harmonic	RO	%	32 bit flo t
104	L1 I Harmonics5	Phase1 current 5th harmonic	RO	%	32 bit flo t
106	L1 I Harmonics7	Phase1 current 7th harmonic	RO	%	32 bit flo t
108	L1 I Harmonics9	Phase1 current 9th harmonic	RO	%	32 bit flo t
110	L1 I Harmonics11	Phase1 current 11th harmonic	RO	%	32 bit flo t
112	L1 I Harmonics13	Phase1 current 13th harmonic	RO	%	32 bit flo t
114	L1 I Harmonics15	Phase1 current 15th harmonic	RO	%	32 bit flo t

Address	Parameter	Description	R/W	Unit	Data Type
116	L1 I Harmonics17	Phase1 current 17th harmonic	RO	%	32 bit flo t
118	L1 I Harmonics19	Phase1 current 19th harmonic	RO	%	32 bit flo t
120	L1 I Harmonics21	Phase1 current 21th harmonic	RO	%	32 bit flo t
122	L1 I Harmonics23	Phase1 current 23th harmonic	RO	%	32 bit flo t
124	L1 I Harmonics25	Phase1 current 25th harmonic	RO	%	32 bit flo t
126	L1 I Harmonics27	Phase1 current 27th harmonic	RO	%	32 bit flo t
128	L1 I Harmonics29	Phase1 current 29th harmonic	RO	%	32 bit flo t
130	L1 I Harmonics31	Phase1 current 31th harmonic	RO	%	32 bit flo t
132	L1 I Harmonics33	Phase1 current 33th harmonic	RO	%	32 bit flo t
134	L1 I Harmonics35	Phase1 current 35th harmonic	RO	%	32 bit flo t
136	L1 I Harmonics37	Phase1 current 37th harmonic	RO	%	32 bit flo t
138	L1 I Harmonics39	Phase1 current 39th harmonic	RO	%	32 bit flo t
140	L1 I Harmonics41	Phase1 current 41th harmonic	RO	%	32 bit flo t
142	L1 I Harmonics43	Phase1 current 43th harmonic	RO	%	32 bit flo t
144	L1 I Harmonics45	Phase1 current 45th harmonic	RO	%	32 bit flo t
146	L1 I Harmonics47	Phase1 current 47th harmonic	RO	%	32 bit flo t
148	L1 I Harmonics49	Phase1 current 49th harmonic	RO	%	32 bit flo t
150	L1 I Harmonics51	Phase1 current 51th harmonic	RO	%	32 bit flo t
Phase 2					
152	L2 V	Phase2 voltage	RO	V	32 bit flo t
154	L2 I	Phase2 current	RO	A	32 bit flo t
156	L2 P	Phase2 active power	RO	W	32 bit flo t
158	L2 Q	Phase2 reactive power	RO	VAr	32 bit flo t
160	L2 S	Phase2 apparent power	RO	VA	32 bit flo t
162	L2 CosØ	Phase2 CosØ	RO	-	32 bit flo t
164	L2 PF	Phase2 power factor	RO	-	32 bit flo t
166	L2 F	Phase2 frequency	RO	Hz	32 bit flo t
168	L2 THDV	Phase2 total har. distortion of voltage	RO	%	32 bit flo t
170	L2 THDI	Phase2 total har. distortion of current	RO	%	32 bit flo t
172	L2 V Harmonics1	Phase2 voltage first harmonic	RO	%	32 bit flo t
174	L2 V Harmonics3	Phase2 voltage third harmonic	RO	%	32 bit flo t
176	L2 V Harmonics5	Phase2 voltage 5th harmonic	RO	%	32 bit flo t
178	L2 V Harmonics7	Phase2 voltage 7th harmonic	RO	%	32 bit flo t
180	L2 V Harmonics9	Phase2 voltage 9th harmonic	RO	%	32 bit flo t
182	L2 V Harmonics11	Phase2 voltage 11th harmonic	RO	%	32 bit flo t
184	L2 V Harmonics13	Phase2 voltage 13th harmonic	RO	%	32 bit flo t
186	L2 V Harmonics15	Phase2 voltage 15th harmonic	RO	%	32 bit flo t
188	L2 V Harmonics17	Phase2 voltage 17th harmonic	RO	%	32 bit flo t
190	L2 V Harmonics19	Phase2 voltage 19th harmonic	RO	%	32 bit flo t
192	L2 V Harmonics21	Phase2 voltage 21th harmonic	RO	%	32 bit flo t
194	L2 V Harmonics23	Phase2 voltage 23th harmonic	RO	%	32 bit flo t
196	L2 V Harmonics25	Phase2 voltage 25th harmonic	RO	%	32 bit flo t
198	L2 V Harmonics27	Phase2 voltage 27th harmonic	RO	%	32 bit flo t
200	L2 V Harmonics29	Phase2 voltage 29th harmonic	RO	%	32 bit flo t
202	L2 V Harmonics31	Phase2 voltage 31th harmonic	RO	%	32 bit flo t

Address	Parameter	Description	R/W	Unit	Data Type
204	L2 V Harmonics33	Phase2 voltage 33th harmonic	RO	%	32 bit flo t
206	L2 V Harmonics35	Phase2 voltage 35th harmonic	RO	%	32 bit flo t
208	L2 V Harmonics37	Phase2 voltage 37th harmonic	RO	%	32 bit flo t
210	L2 V Harmonics39	Phase2 voltage 39th harmonic	RO	%	32 bit flo t
212	L2 V Harmonics41	Phase2 voltage 41th harmonic	RO	%	32 bit flo t
214	L2 V Harmonics43	Phase2 voltage 43th harmonic	RO	%	32 bit flo t
216	L2 V Harmonics45	Phase2 voltage 45th harmonic	RO	%	32 bit flo t
218	L2 V Harmonics47	Phase2 voltage 47th harmonic	RO	%	32 bit flo t
220	L2 V Harmonics49	Phase2 voltage 49th harmonic	RO	%	32 bit flo t
222	L2 V Harmonics51	Phase2 voltage 51th harmonic	RO	%	32 bit flo t
226	L2 I Harmonics1	Phase2 current first harmonic	RO	%	32 bit flo t
228	L2 I Harmonics3	Phase2 current third harmonic	RO	%	32 bit flo t
230	L2 I Harmonics5	Phase2 current 5th harmonic	RO	%	32 bit flo t
232	L2 I Harmonics7	Phase2 current 7th harmonic	RO	%	32 bit flo t
234	L2 I Harmonics9	Phase2 current 9th harmonic	RO	%	32 bit flo t
236	L2 I Harmonics11	Phase2 current 11th harmonic	RO	%	32 bit flo t
238	L2 I Harmonics13	Phase2 current 13th harmonic	RO	%	32 bit flo t
240	L2 I Harmonics15	Phase2 current 15th harmonic	RO	%	32 bit flo t
242	L2 I Harmonics17	Phase2 current 17th harmonic	RO	%	32 bit flo t
244	L2 I Harmonics19	Phase2 current 19th harmonic	RO	%	32 bit flo t
246	L2 I Harmonics21	Phase2 current 21th harmonic	RO	%	32 bit flo t
248	L2 I Harmonics23	Phase2 current 23th harmonic	RO	%	32 bit flo t
250	L2 I Harmonics25	Phase2 current 25th harmonic	RO	%	32 bit flo t
252	L2 I Harmonics27	Phase2 current 27th harmonic	RO	%	32 bit flo t
254	L2 I Harmonics29	Phase2 current 29th harmonic	RO	%	32 bit flo t
256	L2 I Harmonics31	Phase2 current 31th harmonic	RO	%	32 bit flo t
258	L2 I Harmonics33	Phase2 current 33th harmonic	RO	%	32 bit flo t
260	L2 I Harmonics35	Phase2 current 35th harmonic	RO	%	32 bit flo t
262	L2 I Harmonics39	Phase2 current 39th harmonic	RO	%	32 bit flo t
264	L2 I Harmonics41	Phase2 current 41th harmonic	RO	%	32 bit flo t
266	L2 I Harmonics43	Phase2 current 43th harmonic	RO	%	32 bit flo t
268	L2 I Harmonics45	Phase2 current 45th harmonic	RO	%	32 bit flo t
270	L2 I Harmonics47	Phase2 current 47th harmonic	RO	%	32 bit flo t
272	L2 I Harmonics49	Phase2 current 49th harmonic	RO	%	32 bit flo t
274	L2 I Harmonics51	Phase2 current 51th harmonic	RO	%	32 bit flo t
Phase 3					
276	L3 V	Phase3 voltage	RO	V	32 bit flo t
278	L3 I	Phase3 current	RO	A	32 bit flo t
280	L3 P	Phase3 active power	RO	W	32 bit flo t
282	L3 Q	Phase3 reactive power	RO	VAr	32 bit flo t
284	L3 S	Phase3 apparent power	RO	VA	32 bit flo t
286	L3 CosØ	Phase3 CosØ	RO	-	32 bit flo t
288	L3 PF	Phase3 power factor	RO	-	32 bit flo t
290	L3 F	Phase3 frequency	RO	Hz	32 bit flo t
292	L3 THDV	Phase3 total har. distortion of voltage	RO	%	32 bit flo t
294	L3 THDI	Phase3 total har. distortion of current	RO	%	32 bit flo t
296	L3 V Harmonics1	Phase3 voltage first harmonic	RO	%	32 bit flo t

Address	Parameter	Description	R/W	Unit	Data Type
298	L3 V Harmonics3	Phase3 voltage third harmonic	RO	%	32 bit flo t
300	L3 V Harmonics5	Phase3 voltage 5th harmonic	RO	%	32 bit flo t
302	L3 V Harmonics7	Phase3 voltage 7th harmonic	RO	%	32 bit flo t
304	L3 V Harmonics9	Phase3 voltage 9th harmonic	RO	%	32 bit flo t
306	L3 V Harmonics11	Phase3 voltage 11th harmonic	RO	%	32 bit flo t
308	L3 V Harmonics13	Phase3 voltage 13th harmonic	RO	%	32 bit flo t
310	L3 V Harmonics15	Phase3 voltage 15th harmonic	RO	%	32 bit flo t
312	L3 V Harmonics17	Phase3 voltage 17th harmonic	RO	%	32 bit flo t
314	L3 V Harmonics19	Phase3 voltage 19th harmonic	RO	%	32 bit flo t
316	L3 V Harmonics21	Phase3 voltage 21th harmonic	RO	%	32 bit flo t
318	L3 V Harmonics23	Phase3 voltage 23th harmonic	RO	%	32 bit flo t
320	L3 V Harmonics25	Phase3 voltage 25th harmonic	RO	%	32 bit flo t
322	L3 V Harmonics27	Phase3 voltage 27th harmonic	RO	%	32 bit flo t
324	L3 V Harmonics29	Phase3 voltage 29th harmonic	RO	%	32 bit flo t
326	L3 V Harmonics31	Phase3 voltage 31th harmonic	RO	%	32 bit flo t
328	L3 V Harmonics33	Phase3 voltage 33th harmonic	RO	%	32 bit flo t
320	L3 V Harmonics35	Phase3 voltage 35th harmonic	RO	%	32 bit flo t
322	L3 V Harmonics37	Phase3 voltage 37th harmonic	RO	%	32 bit flo t
324	L3 V Harmonics39	Phase3 voltage 39th harmonic	RO	%	32 bit flo t
326	L3 V Harmonics41	Phase3 voltage 41th harmonic	RO	%	32 bit flo t
328	L3 V Harmonics43	Phase3 voltage 43th harmonic	RO	%	32 bit flo t
340	L3 V Harmonics45	Phase3 voltage 45th harmonic	RO	%	32 bit flo t
342	L3 V Harmonics47	Phase3 voltage 47th harmonic	RO	%	32 bit flo t
344	L3 V Harmonics49	Phase3 voltage 49th harmonic	RO	%	32 bit flo t
346	L3 V Harmonics51	Phase3 voltage 51th harmonic	RO	%	32 bit flo t
348	L3 I Harmonics1	Phase3 current first harmonic	RO	%	32 bit flo t
350	L3 I Harmonics3	Phase3 current third harmonic	RO	%	32 bit flo t
352	L3 I Harmonics5	Phase3 current 5th harmonic	RO	%	32 bit flo t
354	L3 I Harmonics7	Phase3 current 7th harmonic	RO	%	32 bit flo t
356	L3 I Harmonics9	Phase3 current 9th harmonic	RO	%	32 bit flo t
358	L3 I Harmonics11	Phase3 current 11th harmonic	RO	%	32 bit flo t
360	L3 I Harmonics13	Phase3 current 13th harmonic	RO	%	32 bit flo t
362	L3 I Harmonics15	Phase3 current 15th harmonic	RO	%	32 bit flo t
364	L3 I Harmonics17	Phase3 current 17th harmonic	RO	%	32 bit flo t
366	L3 I Harmonics19	Phase3 current 19th harmonic	RO	%	32 bit flo t
368	L3 I Harmonics21	Phase3 current 21th harmonic	RO	%	32 bit flo t
370	L3 I Harmonics23	Phase3 current 23th harmonic	RO	%	32 bit flo t
372	L3 I Harmonics25	Phase3 current 25th harmonic	RO	%	32 bit flo t
374	L3 I Harmonics27	Phase3 current 27th harmonic	RO	%	32 bit flo t
376	L3 I Harmonics29	Phase3 current 29th harmonic	RO	%	32 bit flo t
378	L3 I Harmonics31	Phase3 current 31th harmonic	RO	%	32 bit flo t
380	L3 I Harmonics33	Phase3 current 33th harmonic	RO	%	32 bit flo t
382	L3 I Harmonics35	Phase3 current 35th harmonic	RO	%	32 bit flo t
384	L3 I Harmonics37	Phase3 current 37th harmonic	RO	%	32 bit flo t
386	L3 I Harmonics39	Phase3 current 39th harmonic	RO	%	32 bit flo t
388	L3 I Harmonics41	Phase3 current 41th harmonic	RO	%	32 bit flo t
390	L3 I Harmonics43	Phase3 current 43th harmonic	RO	%	32 bit flo t

Address	Parameter	Description	R/W	Unit	Data Type
392	L3 I Harmonics45	Phase3 current 45th harmonic	RO	%	32 bit flo t
394	L3 I Harmonics47	Phase3 current 47th harmonic	RO	%	32 bit flo t
396	L3 I Harmonics49	Phase3 current 49th harmonic	RO	%	32 bit flo t
398	L3 I Harmonics51	Phase3 current 51th harmonic	RO	%	32 bit flo t
Alarm Flags					
400	Alarms 1	Alarm flag 1 (first 32 bit)	RO	-	32 bit int.
402	Alarms 2	Alarm flag 1 (first 32 bit)	RO	-	32 bit int.
Energy					
404	T1 Imp. Act. Index	Tariff 1 mport Active Index	RO	kWh	32 bit flo t
406	T1 Exp. Act. Index	Tariff 1 Expo t Active Index	RO	kWh	32 bit flo t
408	Reactive R1=> T1	Reactive Region-1 Tariff 1 me er	RO	kVArh	32 bit flo t
410	Reactive R2=> T1	Reactive Region-2 Tariff 1 me er	RO	kVArh	32 bit flo t
412	Reactive R3=> T1	Reactive Region-3 Tariff 1 me er	RO	kVArh	32 bit flo t
414	Reactive R4=> T1	Reactive Region-4 Tariff 1 me er	RO	kVArh	32 bit flo t
416	Imp. Active => T1_1	Import active tariff1 ate 1	RO	kWh	32 bit flo t
418	Exp. Active=> T1_1	Export active tariff1 ate 1	RO	kWh	32 bit flo t
420	Reactive R1=> T1_1	Reactive Region-1 Tariff 1 ate1 meter	RO	kVArh	32 bit flo t
422	Reactive R2=> T1_1	Reactive Region-2 Tariff 1 ate1 meter	RO	kVArh	32 bit flo t
424	Reactive R3=> T1_1	Reactive Region-3 Tariff 1 ate1 meter	RO	kVArh	32 bit flo t
426	Reactive R4=> T1_1	Reactive Region-4 Tariff 1 ate1 meter	RO	kVArh	32 bit flo t
428	Imp. Active => T1_2	Import active tariff1 ate 2	RO	kWh	32 bit flo t
430	Exp. Active=> T1_2	Export active tariff1 ate 2	RO	kWh	32 bit flo t
432	Reactive R1=> T1_2	Reactive Region-1 Tariff 1 ate2 meter	RO	kVArh	32 bit flo t
434	Reactive R2=> T1_2	Reactive Region-2 Tariff 1 ate2 meter	RO	kVArh	32 bit flo t
436	Reactive R3=> T1_2	Reactive Region-3 Tariff 1 ate2 meter	RO	kVArh	32 bit flo t
438	Reactive R4=> T1_2	Reactive Region-4 Tariff 1 ate2 meter	RO	kVArh	32 bit flo t
440	Imp. Active => T1_3	Import active tariff1 ate 3	RO	kWh	32 bit flo t
442	Exp. Active=> T1_3	Export active tariff1 ate 3	RO	kWh	32 bit flo t
444	Reactive R1=> T1_3	Reactive Region-1 Tariff 1 ate3 meter	RO	kVArh	32 bit flo t
446	Reactive R2=> T1_3	Reactive Region-2 Tariff 1 ate3 meter	RO	kVArh	32 bit flo t
448	Reactive R3=> T1_3	Reactive Region-3 Tariff 1 ate3 meter	RO	kVArh	32 bit flo t
450	Reactive R4=> T1_3	Reactive Region-4 Tariff 1 ate3 meter	RO	kVArh	32 bit flo t
452	Imp. Active => T2	Import active tariff	RO	kWh	32 bit flo t
454	Exp. Active=> T2	Export active tariff	RO	kWh	32 bit flo t
456	Reactive R1=> T2	Reactive Region-1 Tariff2 me er	RO	kVArh	32 bit flo t
458	Reactive R2=> T2	Reactive Region-2 Tariff 2 me er	RO	kVArh	32 bit flo t
460	Reactive R3=> T2	Reactive Region-3 Tariff 2 me er	RO	kVArh	32 bit flo t
462	Reactive R4=> T2	Reactive Region-4 Tariff 2 me er	RO	kVArh	32 bit flo t
Demand					
464	Curr. Month P tot.	Current Month Total Active Power	RO	W	32 bit flo t
466	Curr. Month P tot. time	Current Month Total Active Power Timestamp	RO	-	32 bit unix time
468	Curr. Month I tot.	Current Month Total Current	RO	A	32 bit flo t
470	Curr. Month I tot. time	Current Month Total Current Timestamp	RO	-	32 bit unix time
472	Curr. Month Q tot.	Current Month Total Reactive Power	RO	VAr	32 bit flo t
474	Curr. Month Q tot. time	Current Month Total Reactive Power Timestamp	RO	-	32 bit unix time
476	Curr. Month S tot.	Current Month Total Apparent Power	RO	VA	32 bit flo t
478	Curr. Month S tot. Time	Current Month Total Apparent Power Timestamp	RO	-	32 bit unix time

Address	Parameter	Description	R/W	Unit	Data Type
480	Curr. Month L1 P	Current Month Phase 1 Active Power	RO	W	32 bit flo t
482	Curr. Month L1 P time	Current Month Phase 1 Active Power Timestamp	RO	-	32 bit unix time
484	Curr. Month L1 I	Current Month Phase 1 Active Power Timestamp	RO	A	32 bit flo t
486	Curr. Month L1 I time	Current Month Phase 1 Current Timestamp	RO	-	32 bit unix time
488	Curr. Month L1 Q	Current Month Phase 1 Reactive Power	RO	VAr	32 bit flo t
490	Curr. Month L1 Q time	Current Month Phase 1 Reactive Power Timestamp	RO	-	32 bit unix time
492	Curr. Month L1 S	Current Month Phase 1 Apparent Power	RO	VA	32 bit flo t
494	Curr. Month L1 S time	Current Month Phase 1 Apparent Power Timestamp	RO	-	32 bit unix time
496	Curr. Month L2 P	Current Month Phase 2 Active Power	RO	W	32 bit flo t
498	Curr. Month L2 P time	Current Month Phase 2 Active Power Timestamp	RO	-	32 bit unix time
500	Curr. Month L2 I	Current Month Phase 2 Current	RO	A	32 bit flo t
502	Curr. Month L2 I time	Current Month Phase 2 Current Timestamp	RO	-	32 bit unix time
504	Curr. Month L2 Q	Current Month Phase 2 Reactive Power	RO	VAr	32 bit flo t
506	Curr. Month L2 Q time	Current Month Phase 2 Reactive Power Timestamp	RO	-	32 bit unix time
508	Curr. Month L2 S	Current Month Phase 2 Apparent Power	RO	VA	32 bit flo t
510	Curr. Month L2 S time	Current Month Phase 2 Apparent Power Timestamp	RO	-	32 bit unix time
512	Curr. Month L3 P	Current Month Phase 3 Active Power	RO	W	32 bit flo t
514	Curr. Month L3 P time	Current Month Phase 3 Active Power Timestamp	RO	-	32 bit unix time
516	Curr. Month L3 I	Current Month Phase 3 Current	RO	A	32 bit flo t
518	Curr. Month L3 I time	Current Month Phase 3 Current Timestamp	RO	-	32 bit unix time
520	Curr. Month L3 Q	Current Month Phase 3 Reactive Power	RO	VAr	32 bit flo t
522	Curr. Month L3 Q time	Current Month Phase 3 Reactive Power Timestamp	RO	-	32 bit unix time
524	Curr. Month L3 S	Current Month Phase 3 Apparent Power	RO	VA	32 bit flo t
526	Curr. Month L3 S time	Current Month Phase 3 Apparent Power Timestamp	RO	-	32 bit unix time
528	1 month ago P tot.	1 Month Ago Total Active Power	RO	W	32 bit flo t
530	1 month ago P tot. time	1 Month Ago Total Active Power Timestamp	RO	-	32 bit unix time
532	1 month ago I tot.	1 Month Ago Total Current	RO	A	32 bit flo t
534	1 month ago I tot. time	1 Month Ago Total Current Timestamp	RO	-	32 bit unix time
536	1 month ago Q tot.	1 Month Ago Total Reactive Power	RO	VAr	32 bit flo t
538	1 month ago Q tot. time	1 Month Ago Total Reactive Power Timestamp	RO	-	32 bit unix time
540	1 month ago S tot.	1 Month Ago Total Apparent Power	RO	VA	32 bit flo t
542	1 month ago S tot. time	1 Month Ago Total Apparent Power Timestamp	RO	-	32 bit unix time
544	1 month ago L1 P	1 Month Ago Phase 1 Active Power	RO	W	32 bit flo t
546	1 month ago L1 P time	1 Month Ago Phase 1 Active Power Timestamp	RO	-	32 bit unix time
548	1 month ago L1 I	1 Month Ago Phase 1 Current	RO	A	32 bit flo t
550	1 month ago L1 I time	1 Month Ago Phase 1 Current Timestamp	RO	-	32 bit unix time
552	1 month ago L1 Q	1 Month Ago Phase 1 Reactive Power	RO	VAr	32 bit flo t
554	1 month ago L1 Q time	1 Month Ago Phase 1 Reactive Power Timestamp	RO	-	32 bit unix time
556	1 month ago L1 S	1 Month Ago Phase 1 Apparent Power	RO	VA	32 bit flo t
558	1 month ago L1 S time	1 Month Ago Phase 1 Apparent Power Timestamp	RO	-	32 bit unix time
560	1 month ago L2 P	1 Month Ago Phase 2 Active Power Value	RO	W	32 bit flo t
562	1 month ago L2 P time	1 Month Ago Phase 2 Active Power Timestamp	RO	-	32 bit unix time
564	1 month ago L2 I	1 Month Ago Phase 2 Current Value	RO	A	32 bit flo t
566	1 month ago L2 I time	1 Month Ago Phase 2 Current Timestamp	RO	-	32 bit unix time
568	1 month ago L2 Q	1 Month Ago Phase 2 Reactive Power	RO	VAr	32 bit unix time
570	1 month ago L2 Q time	1 Month Ago Phase 2 Reactive Power Timestamp	RO	-	32 bit flo t
572	1 month ago L2 S	1 Month Ago Phase 2 Apparent Power	RO	VA	32 bit unix time

Address	Parameter	Description	R/W	Unit	Data Type
574	1 month ago L2 S time	1 Month Ago Phase 2 Apparent Power Timestamp	RO	-	32 bit flo t
576	1 month ago L3 P	1 Month Ago Phase 3 Active Power	RO	W	32 bit unix time
578	1 month ago L3 P time	1 Month Ago Phase 3 Active Power Timestamp	RO	-	32 bit flo t
580	1 month ago L3 I	1 Month Ago Phase 3 Current	RO	A	32 bit unix time
582	1 month ago L3 I time	1 Month Ago Phase 3 Current Timestamp	RO	-	32 bit flo t
584	1 month ago L3 Q	1 Month Ag Phase 3 Reactive Power	RO	VAr	32 bit unix time
586	1 month ago L3 Q time	1 Month Ago Phase 3 Reactive Power Timestamp	RO	-	32 bit flo t
588	1 month ago L3 S	1 Month Ago Phase 3 Apparent Power	RO	VA	32 bit unix time
590	1 month ago L3 S time	1 Month Ago Phase 3 Apparent Power Timestamp	RO	-	32 bit flo t
592	2 months ago Total P	2 Months Ago Total Active Power	RO	W	32 bit flo t
594	2 months ago Total P time	2 Months Ago Total Active Power Timestamp	RO	-	32 bit unix time
596	2 months ago Total I	2 Months Ago Total Current	RO	A	32 bit flo t
598	2 months ago Total I	2 Months Ago Total Current Timestamp	RO	-	32 bit unix time
600	2 months ago Q top.	2 Months Ago Total Reactive Power	RO	VAr	32 bit flo t
602	2 months ago Total Q time	2 Months Ago Total Reactive Power Timestamp	RO	-	32 bit unix time
604	2 months ago Total S	2 Months Ago Total Apparent Power	RO	VA	32 bit flo t
606	2 months ago Total S time	2 Months Ago Total Apparent Power Timestamp	RO	-	32 bit unix time
608	2 months ago L1 P	2 Months Ago Phase 1 Active Power	RO	W	32 bit flo t
610	2 months ago L1 P time	2 Months Ago Phase 1 Active Power Timestamp	RO	-	32 bit unix time
612	2 months ago L1 I	2 Months Ago Phase 1 Current	RO	A	32 bit flo t
614	2 months ago L1 I time	2 Months Ago Phase 1 Current Timestamp	RO	-	32 bit unix time
616	2 months ago L1 Q	2 Months Ago Phase 1 Reactive Power	RO	VAr	32 bit flo t
618	2 months ago L1 Q time	2 Months Ago Phase 1 Reactive Power Timestamp	RO	-	32 bit unix time
620	2 months ago L1 S	2 Months Ago Phase 1 Apparent Power	RO	VA	32 bit flo t
622	2 months ago L1 S time	2 Months Ago Phase 1 Apparent Power Timestamp	RO	-	32 bit unix time
624	2 months ago L2 P	2 Months Ago Phase 2 Active Power	RO	W	32 bit flo t
626	2 months ago L2 P time	2 Months Ago Phase 2 Active Power Timestamp	RO	-	32 bit unix time
628	2 months ago L2 I	2 Months Ago Phase 2 Current	RO	A	32 bit flo t
630	2 months ago L2 I time	2 Months Ago Phase 2 Current Timestamp	RO	-	32 bit unix time
632	2 months ago L2 Q	2 Months Ago Phase 2 Reactive Power	RO	VAr	32 bit flo t
634	2 months ago L2 Q time	2 Months Ago Phase 2 Reactive Power Timestamp	RO	-	32 bit unix time
636	2 months ago L2 S	2 Months Ago Phase 2 Apparent Power	RO	VA	32 bit flo t
638	2 months ago L2 S time	2 Months Ago Phase 2 Apparent Power Timestamp	RO	-	32 bit unix time
640	2 months ago L3 P	2 Months Ago Phase 3 Active Power	RO	W	32 bit flo t
642	2 months ago L3 P time	2 Months Ago Phase 3 Active Power	RO	-	32 bit unix time
644	2 months ago L3 I	2 Months Ago Phase 3 Current	RO	A	32 bit flo t
646	2 months ago L3 I time	2 Months Ago Phase 3 Current Timestamp	RO	-	32 bit unix time
648	2 months ago L3 Q	2 Months Ago Phase 3 Reactive Power	RO	VAr	32 bit flo t
650	2 months ago L3 Q time	2 Months Ago Phase 3 Reactive Power Timestamp	RO	-	32 bit unix time
652	2 months ago L3 S	2 Months Ago Phase 3 Apparent Power	RO	VA	32 bit flo t
654	2 months ago L3 S time	2 Months Ago Phase 3 Apparent Power Timestamp	RO	-	32 bit flo t
656	3 months ago Total P	3 Months Ago Total Active Power	RO	W	32 bit unix time
658	3 months ago Total P time	3 Months Ago Total Active Power Timestamp	RO	-	32 bit flo t
660	3 months ago Total I	3 Months Ago Total Current	RO	A	32 bit unix time
662	3 months ago Total I time	3 Months Ago Total Current Timestamp	RO	-	32 bit flo t
664	3 months ago Q top.	3 Months Ago Total Reactive Power	RO	VAr	32 bit unix time
666	3 months ago Total Q time	3 Months Ago Total Reactive Power Timestamp	RO	-	32 bit flo t
668	3 months ago Total S	3 Months Ago Total Apparent Power	RO	VA	32 bit unix time

Address	Parameter	Description	R/W	Unit	Data Type
670	3 months ago Total S time	3 Months Ago Total Apparent Power Timestamp	RO	-	32 bit flo t
672	3 months ago L1 P	3 Months Ago Phase 1 Active Power	RO	W	32 bit unix time
674	3 months ago L1 P time	3 Months Ago Phase 1 Active Power Timestamp	RO	-	32 bit flo t
676	3 months ago L1 I	3 Months Ago Phase 1 Current	RO	A	32 bit unix time
678	3 months ago L1 I time	3 Months Ago Phase 1 Current Timestamp	RO	-	32 bit flo t
680	3 months ago L1 Q	3 Months Ago Phase 1 Reactive Power	RO	VAr	32 bit unix time
682	3 months ago L1 Q time	3 Months Ago Phase 1 Reactive Power Timestamp	RO	-	32 bit flo t
684	3 months ago L1 S	3 Months Ago Phase 1 Apparent Power	RO	VA	32 bit unix time
686	3 months ago L1 S time	3 Months Ago Phase 1 Apparent Power Timestamp	RO	-	32 bit flo t
688	3 months ago L2 P	3 Months Ago Phase 2 Active Power	RO	W	32 bit unix time
690	3 months ago L2 P time	3 Months Ago Phase 2 Active Power Timestamp	RO	-	32 bit flo t
692	3 months ago L2 I	3 Months Ago Phase 2 Current	RO	A	32 bit unix time
694	3 months ago L2 I time	3 Months Ago Phase 2 Current Timestamp	RO	-	32 bit unix time
696	3 months ago L2 Q	3 Months Ago Phase 2 Reactive Power	RO	VAr	32 bit flo t
698	3 months ago L2 Q time	3 Months Ago Phase 2 Reactive Power Timestamp	RO	-	32 bit unix time
700	3 months ago L2 S	3 Months Ago Phase 2 Apparent Power	RO	VA	32 bit flo t
702	3 months ago L2 S time	3 Months Ago Phase 2 Apparent Power Timestamp	RO	-	32 bit unix time
704	3 months ago L3 P	3 Months Ago Phase 3 Active Power	RO	W	32 bit flo t
706	3 months ago L3 P time	3 Months Ago Phase 3 Active Power Timestamp	RO	-	32 bit unix time
708	3 months ago L3 I	3 Months Ago Phase 3 Current	RO	A	32 bit flo t
710	3 months ago L3 I time	3 Months Ago Phase 3 Current Timestamp	RO	-	32 bit unix time
712	3 months ago L3 Q	3 Months Ago Phase 3 Reactive Power	RO	VAr	32 bit flo t
714	3 months ago L3 Q time	3 Months Ago Phase 3 Reactive Power Timestamp	RO	-	32 bit unix time
716	3 months ago L3 S	3 Months Ago Phase 3 Apparent Power	RO	VA	32 bit flo t
718	3 months ago L3 S time	3 Months Ago Phase 3 Apparent Power Timestamp	RO	-	32 bit unix time
DI Accumulators					
720	DI1 Counter	Digital Input1 Counter Value	RO	-	32 bit flo t
722	DI2 Counter	Digital Input2 Counter Value	RO	-	32 bit flo t
Other					
724	Temp.	Temperature Value	RO	°C	32 bit flo t
726	Battery Voltage	-	RO	V	32 bit flo t
728	Time	System Date and Time	R/W	-	32 bit unix time
DI Accumulators (Optional DIO Model)					
730	DI3 Counter	Digital Input3 Counter Value	RO	-	32 bit flo t
732	DI4 Counter	Digital Input4 Counter Value	RO	-	32 bit flo t
734	DI5 Counter	Digital Input5 Counter Value	RO	-	32 bit flo t
736	DI6 Counter	Digital Input6 Counter Value	RO	-	32 bit flo t
738	DI7 Counter	Digital Input7 Counter Value	RO	-	32 bit flo t
Alarm Satatuses					
740	1 - Alarm Timestamp	1 - Alarm time	RO	-	32 bit unix time
742	1 - Alarm ID	1 - Alarm ID	RO	-	32 bit int.
744	1 - Alarm Status	1 - Alarm ON /Alarm OFF status	RO	-	32 bit int.
746	1 - Alarm Value	1 - Value of related alarm parameter	RO	-	32 bit flo t
748	2 - Alarm Timestamp	2 - Alarm time	RO	-	32 bit unix time
750	2 - Alarm ID	2 - Alarm ID	RO	-	32 bit int.
752	2 - Alarm Status	2 - Alarm ON /Alarm OFF status	RO	-	32 bit int.
754	2 - Alarm Value	2 - Value of related alarm parameter	RO	-	32 bit flo t

Address	Parameter	Description	R/W	Unit	Data Type
756	3 - Alarm Timestamp	3 - Alarm time	RO	-	32 bit unix time
758	3 - Alarm ID	3 - Alarm ID	RO	-	32 bit int.
760	3 - Alarm Status	3 - Alarm ON /Alarm OFF status	RO	-	32 bit int.
762	3 - Alarm Value	3 - Value of related alarm parameter	RO	-	32 bit flo t
764	4 - Alarm Timestamp	4 - Alarm time	RO	-	32 bit unix time
766	4 - Alarm ID	4 - Alarm ID	RO	-	32 bit int.
768	4 - Alarm Status	4 - Alarm ON /Alarm OFF status	RO	-	32 bit int.
770	4 - Alarm Value	4 - Value of related alarm parameter	RO	-	32 bit flo t
772	5 - Alarm Timestamp	5 - Alarm time	RO	-	32 bit unix time
774	5 - Alarm ID	5 - Alarm ID	RO	-	32 bit int.
776	5 - Alarm Status	5 - Alarm ON /Alarm OFF status	RO	-	32 bit int.
778	5 - Alarm Value	5 - Value of related alarm parameter	RO	-	32 bit flo t
780	6 - Alarm Timestamp	6 - Alarm time	RO	-	32 bit unix time
782	6 - Alarm ID	6 - Alarm ID	RO	-	32 bit int.
784	6 - Alarm Status	6 - Alarm ON /Alarm OFF status	RO	-	32 bit int.
786	6 - Alarm Value	6 - Value of related alarm parameter	RO	-	32 bit flo t
788	7 - Alarm Timestamp	7 - Alarm time	RO	-	32 bit unix time
790	7 - Alarm ID	7 - Alarm ID	RO	-	32 bit int.
792	7 - Alarm Status	7 - Alarm ON /Alarm OFF status	RO	-	32 bit int.
794	7 - Alarm Value	7 - Value of related alarm parameter	RO	-	32 bit flo t
796	8 - Alarm Timestamp	8 - Alarm time	RO	-	32 bit unix time
798	8 - Alarm ID	8 - Alarm ID	RO	-	32 bit int.
800	8 - Alarm Status	8 - Alarm ON /Alarm OFF status	RO	-	32 bit int.
802	8 - Alarm Value	8 - Value of related alarm parameter	RO	-	32 bit flo t
804	9 - Alarm Timestamp	9 - Alarm time	RO	-	32 bit unix time
806	9 - Alarm ID	9 - Alarm ID	RO	-	32 bit int.
808	9 - Alarm Status	9 - Alarm ON /Alarm OFF status	RO	-	32 bit int.
810	9 - Alarm Value	9 - Value of related alarm parameter	RO	-	32 bit flo t
812	10 - Alarm Timestamp	10 - Alarm time	RO	-	32 bit unix time
814	10 - Alarm ID	10 - Alarm ID	RO	-	32 bit int.
816	10 - Alarm Status	10 - Alarm ON /Alarm OFF status	RO	-	32 bit int.
818	10 - Alarm Value	10 - Value of related alarm parameter	RO	-	32 bit flo t
820	11 - Alarm Timestamp	11 - Alarm time	RO	-	32 bit unix time
822	11 - Alarm ID	11 - Alarm ID	RO	-	32 bit int.
824	11 - Alarm Status	11 - Alarm ON /Alarm OFF status	RO	-	32 bit int.
826	11 - Alarm Value	11 - Value of related alarm parameter	RO	-	32 bit flo t
828	12 - Alarm Timestamp	12 - Alarm time	RO	-	32 bit unix time
830	12 - Alarm ID	12 - Alarm ID	RO	-	32 bit int.
832	12 - Alarm Status	12 - Alarm ON /Alarm OFF status	RO	-	32 bit int.
834	12 - Alarm Value	12 - Value of related alarm parameter	RO	-	32 bit flo t
836	13 - Alarm Timestamp	13 - Alarm time	RO	-	32 bit unix time
838	13 - Alarm ID	13 - Alarm ID	RO	-	32 bit int.
840	13 - Alarm Status	13 - Alarm ON /Alarm OFF status	RO	-	32 bit int.
842	13 - Alarm Value	13 - Value of related alarm parameter	RO	-	32 bit flo t
844	14 - Alarm Timestamp	14 - Alarm time	RO	-	32 bit unix time
846	14 - Alarm ID	14 - Alarm ID	RO	-	32 bit int.
848	14 - Alarm Status	14 - Alarm ON /Alarm OFF status	RO	-	32 bit int.

Address	Parameter	Description	R/W	Unit	Data Type
850	14 - Alarm Value	14 - Value of related alarm parameter	RO	-	32 bit flo t
852	15 - Alarm Timestamp	15 - Alarm time	RO	-	32 bit unix time
854	15 - Alarm ID	15 - Alarm ID	RO	-	32 bit int.
856	15 - Alarm Status	15 - Alarm ON /Alarm OFF status	RO	-	32 bit int.
858	15 - Alarm Value	15 - Value of related alarm parameter	RO	-	32 bit flo t
860	16 - Alarm Timestamp	16 - Alarm time	RO	-	32 bit unix time
862	16 - Alarm ID	16 - Alarm ID	RO	-	32 bit int.
864	16 - Alarm Status	16 - Alarm ON /Alarm OFF status	RO	-	32 bit int.
866	16 - Alarm Value	16 - Value of related alarm parameter	RO	-	32 bit flo t
868	17 - Alarm Timestamp	17 - Alarm time	RO	-	32 bit unix time
870	17 - Alarm ID	17 - Alarm ID	RO	-	32 bit int.
872	17 - Alarm Status	17 - Alarm ON /Alarm OFF status	RO	-	32 bit int.
874	17 - Alarm Value	17 - Value of related alarm parameter	RO	-	32 bit flo t
876	18 - Alarm Timestamp	18 - Alarm time	RO	-	32 bit unix time
878	18 - Alarm ID	18 - Alarm ID	RO	-	32 bit int.
880	18 - Alarm Status	18 - Alarm ON /Alarm OFF status	RO	-	32 bit int.
882	18 - Alarm Value	18 - Value of related alarm parameter	RO	-	32 bit flo t
884	19- Alarm Timestamp	19 - Alarm time	RO	-	32 bit unix time
886	19 - Alarm ID	19 - Alarm ID	RO	-	32 bit int.
888	19- Alarm Status	19 - Alarm ON /Alarm OFF status	RO	-	32 bit int.
890	19 - Alarm Value	19- Value of related alarm parameter	RO	-	32 bit flo t
892	20 - Alarm Timestamp	20 - Alarm time	RO	-	32 bit unix time
894	20 - Alarm ID	20 - Alarm ID	RO	-	32 bit int.
896	20 - Alarm Status	20 - Alarm ON /Alarm OFF status	RO	-	32 bit int.
898	20 - Alarm Value	20 - Value of related alarm parameter	RO	-	32 bit flo t
900	21 - Alarm Timestamp	21 - Alarm time	RO	-	32 bit unix time
902	21 - Alarm ID	21 - Alarm ID	RO	-	32 bit int.
904	21 - Alarm Status	21 - Alarm ON /Alarm OFF status	RO	-	32 bit int.
906	21 - Alarm Value	21 - Value of related alarm parameter	RO	-	32 bit flo t
908	22 - Alarm Timestamp	22 - Alarm time	RO	-	32 bit unix time
910	22 - Alarm ID	22 - Alarm ID	RO	-	32 bit int.
912	22 - Alarm Status	22 - Alarm ON /Alarm OFF status	RO	-	32 bit int.
914	22 - Alarm Value	22 - Value of related alarm parameter	RO	-	32 bit flo t
916	23 - Alarm Timestamp	23 - Alarm time	RO	-	32 bit unix time
918	23 - Alarm ID	23 - Alarm ID	RO	-	32 bit int.
920	23 - Alarm Status	23 - Alarm ON /Alarm OFF status	RO	-	32 bit int.
922	23 - Alarm Value	23 - Value of related alarm parameter	RO	-	32 bit flo t
924	24 - Alarm Timestamp	24 - Alarm time	RO	-	32 bit unix time
926	24 - Alarm ID	24 - Alarm ID	RO	-	32 bit int.
928	24 - Alarm Status	24 - Alarm ON /Alarm OFF status	RO	-	32 bit int.
930	24 - Alarm Value	24 - Value of related alarm parameter	RO	-	32 bit flo t
932	25 - Alarm Timestamp	25 - Alarm time	RO	-	32 bit unix time
934	25 - Alarm ID	25 - Alarm ID	RO	-	32 bit int.
936	25 - Alarm Status	25 - Alarm ON /Alarm OFF status	RO	-	32 bit int.
938	25 - Alarm Value	25 - Value of related alarm parameter	RO	-	32 bit flo t
940	26 - Alarm Timestamp	26 - Alarm time	RO	-	32 bit unix time
942	26 - Alarm ID	26 - Alarm ID	RO	-	32 bit int.

Address	Parameter	Description	R/W	Unit	Data Type
944	26 - Alarm Status	26 - Alarm ON /Alarm OFF status	RO	-	32 bit int.
946	26 - Alarm Value	26 - Value of related alarm parameter	RO	-	32 bit flo t
948	27 - Alarm Timestamp	27 - Alarm time	RO	-	32 bit unix time
950	27 - Alarm ID	27 - Alarm ID	RO	-	32 bit int.
952	27 - Alarm Status	27 - Alarm ON /Alarm OFF status	RO	-	32 bit int.
954	27 - Alarm Value	27 - Value of related alarm parameter	RO	-	32 bit flo t
956	28 - Alarm Timestamp	28 - Alarm time	RO	-	32 bit unix time
958	28 - Alarm ID	28 - Alarm ID	RO	-	32 bit int.
960	28 - Alarm Status	28 - Alarm ON /Alarm OFF status	RO	-	32 bit int.
962	28 - Alarm Value	28 - Value of related alarm parameter	RO	-	32 bit flo t
964	29 - Alarm Timestamp	29 - Alarm time	RO	-	32 bit unix time
966	29 - Alarm ID	29 - Alarm ID	RO	-	32 bit int.
968	29 - Alarm Status	29 - Alarm ON /Alarm OFF status	RO	-	32 bit int.
970	29 - Alarm Value	29 - Value of related alarm parameter	RO	-	32 bit flo t
972	30 - Alarm Timestamp	30 - Alarm time	RO	-	32 bit unix time
974	30 - Alarm ID	30 - Alarm ID	RO	-	32 bit int.
976	30 - Alarm Status	30 - Alarm ON /Alarm OFF status	RO	-	32 bit int.
978	30 - Alarm Value	30 - Value of related alarm parameter	RO	-	32 bit flo t
980	31 - Alarm Timestamp	31 - Alarm time	RO	-	32 bit unix time
982	31 - Alarm ID	31 - Alarm ID	RO	-	32 bit int.
984	31 - Alarm Status	31 - Alarm ON /Alarm OFF status	RO	-	32 bit int.
986	31 - Alarm Value	31 - Value of related alarm parameter	RO	-	32 bit flo t
988	31 - Alarm Timestamp	32 - Alarm time	RO	-	32 bit unix time
990	32 - Alarm ID	32 - Alarm ID	RO	-	32 bit int.
992	32 - Alarm Status	32 - Alarm ON /Alarm OFF status	RO	-	32 bit int.
994	32 - Alarm Value	32 - Value of related alarm parameter	RO	-	32 bit flo t
996	33 - Alarm Timestamp	33 - Alarm time	RO	-	32 bit unix time
998	33 - Alarm ID	33 - Alarm ID	RO	-	32 bit int.
1000	33 - Alarm Status	33 - Alarm ON /Alarm OFF status	RO	-	32 bit int.
1002	33 - Alarm Value	33 - Value of related alarm parameter	RO	-	32 bit flo t
1004	34 - Alarm Timestamp	34 - Alarm time	RO	-	32 bit unix time
1006	34 - Alarm ID	34 - Alarm ID	RO	-	32 bit int.
1008	34 - Alarm Status	34 - Alarm ON /Alarm OFF status	RO	-	32 bit int.
1010	34 - Alarm Value	34 - Value of related alarm parameter	RO	-	32 bit flo t
1012	35 - Alarm Timestamp	35 - Alarm time	RO	-	32 bit unix time
1014	35 - Alarm ID	35 - Alarm ID	RO	-	32 bit int.
1016	35 - Alarm Status	35 - Alarm ON /Alarm OFF status	RO	-	32 bit int.
1018	35 - Alarm Value	35 - Value of related alarm parameter	RO	-	32 bit flo t
1020	36 - Alarm Timestamp	36 - Alarm time	RO	-	32 bit unix time
1022	36 - Alarm ID	36 - Alarm ID	RO	-	32 bit int.
1024	36 - Alarm Status	36 - Alarm ON /Alarm OFF status	RO	-	32 bit int.
1026	36 - Alarm Value	36 - Value of related alarm parameter	RO	-	32 bit flo t
1028	37 - Alarm Timestamp	37 - Alarm time	RO	-	32 bit unix time
1030	37 - Alarm ID	37 - Alarm ID	RO	-	32 bit int.
1032	37 - Alarm Status	37 - Alarm ON /Alarm OFF status	RO	-	32 bit int.

Address	Parameter	Description	R/W	Unit	Data Type
1034	37 - Alarm Value	37 - Value of related alarm parameter	RO	-	32 bit flo t
1036	38 - Alarm Timestamp	38 - Alarm time	RO	-	32 bit unix time
1038	38 - Alarm ID	38 - Alarm ID	RO	-	32 bit int.
1040	38 - Alarm Status	38 - Alarm ON /Alarm OFF status	RO	-	32 bit int.
1042	38 - Alarm Value	38 - Value of related alarm parameter	RO	-	32 bit flo t
1044	39 - Alarm Timestamp	39 - Alarm time	RO	-	32 bit unix time
1046	39 - Alarm ID	39 - Alarm ID	RO	-	32 bit int.
1048	39 - Alarm Status	39 - Alarm ON /Alarm OFF status	RO	-	32 bit int.
1050	39 - Alarm Value	39 - Value of related alarm parameter	RO	-	32 bit flo t
1052	40 - Alarm Timestamp	40 - Alarm time	RO	-	32 bit unix time
1054	40 - Alarm ID	40 - Alarm ID	RO	-	32 bit int.
1056	40 - Alarm Status	40 - Alarm ON /Alarm OFF status	RO	-	32 bit int.
1058	40 - Alarm Value	40 - Value of related alarm parameter	RO	-	32 bit flo t
1060	41 - Alarm Timestamp	41 - Alarm time	RO	-	32 bit unix time
1062	41 - Alarm ID	41 - Alarm ID	RO	-	32 bit int.
1064	41 - Alarm Status	41 - Alarm ON /Alarm OFF status	RO	-	32 bit int.
1066	41 - Alarm Value	41 - Value of related alarm parameter	RO	-	32 bit flo t
1068	42 - Alarm Timestamp	42 - Alarm time	RO	-	32 bit unix time
1070	42 - Alarm ID	42 - Alarm ID	RO	-	32 bit int.
1072	42 - Alarm Status	42 - Alarm ON /Alarm OFF status	RO	-	32 bit int.
1074	42 - Alarm Value	42 - Value of related alarm parameter	RO	-	32 bit flo t
1076	43 - Alarm Timestamp	43 - Alarm time	RO	-	32 bit unix time
1078	43 - Alarm ID	43 - Alarm ID	RO	-	32 bit int.
1080	43 - Alarm Status	43 - Alarm ON /Alarm OFF status	RO	-	32 bit int.
1082	43 - Alarm Value	43 - Value of related alarm parameter	RO	-	32 bit flo t
1084	44 - Alarm Timestamp	44 - Alarm time	RO	-	32 bit unix time
1086	44 - Alarm ID	44 - Alarm ID	RO	-	32 bit int.
1088	44 - Alarm Status	44 - Alarm ON /Alarm OFF status	RO	-	32 bit int.
1090	44 - Alarm Value	44 - Value of related alarm parameter	RO	-	32 bit flo t
1092	45 - Alarm Timestamp	45 - Alarm time	RO	-	32 bit unix time
1094	45 - Alarm ID	45 - Alarm ID	RO	-	32 bit int.
1096	45 - Alarm Status	45 - Alarm ON /Alarm OFF status	RO	-	32 bit int.
1098	45 - Alarm Value	45 - Value of related alarm parameter	RO	-	32 bit flo t
1100	46 - Alarm Timestamp	46 - Alarm time	RO	-	32 bit unix time
1102	46 - Alarm ID	46 - Alarm ID	RO	-	32 bit int.
1104	46 - Alarm Status	46 - Alarm ON /Alarm OFF status	RO	-	32 bit int.
1106	46 - Alarm Value	46 - Value of related alarm parameter	RO	-	32 bit flo t
1108	47 - Alarm Timestamp	47 - Alarm time	RO	-	32 bit unix time
1110	47 - Alarm ID	47 - Alarm ID	RO	-	32 bit int.
1112	47 - Alarm Status	47 - Alarm ON /Alarm OFF status	RO	-	32 bit int.
1114	47 - Alarm Value	47 - Value of related alarm parameter	RO	-	32 bit flo t
1116	48 - Alarm Timestamp	48 - Alarm time	RO	-	32 bit unix time
1118	48 - Alarm ID	48 - Alarm ID	RO	-	32 bit int.
1120	48 - Alarm Status	48 - Alarm ON /Alarm OFF status	RO	-	32 bit int.
1122	48 - Alarm Value	48 - Value of related alarm parameter	RO	-	32 bit flo t
1124	49 - Alarm Timestamp	49 - Alarm time	RO	-	32 bit unix time
1126	49 - Alarm ID	49 - Alarm ID	RO	-	32 bit int.
1128	49 - Alarm Status	49 - Alarm ON /Alarm OFF status	RO	-	32 bit int.

Address	Parameter	Description	R/W	Unit	Data Type
1130	49 - Alarm Value	49 - Value of related alarm parameter	RO	-	32 bit flo t
1132	50 - Alarm Timestamp	50 - Alarm time	RO	-	32 bit unix time
1134	50 - Alarm ID	50 - Alarm ID	RO	-	32 bit int.
1136	50 - Alarm Status	50 - Alarm ON /Alarm OFF status	RO	-	32 bit int.
1138	50 - Alarm Value	50 - Value of related alarm parameter	RO	-	32 bit flo t
Last Saved File Numbers					
1140	Hourly Archival File Num	Last recorded hourly archival file number	RO	-	32 bit int.
1142	Daily Archival File Num.	Last recorded daily archival file number	RO	-	32 bit int.
1144	Monthly Archival File Num.	Last recorded monthly archival file number	RO	-	32 bit int.
Energy(64bit)					
1146	Imp.active=>T1	Import active Tariff 1 me er	RO	kWh	64 bit double
1150	Imp. active=>T1_1	Import active Tariff 1 ate1 meter	RO	kWh	64 bit double
1154	Imp. active=>T1_2	Import active Tariff 1 ate2 meter	RO	kWh	64 bit double
1158	Imp. active=>T1_3	Import active Tariff 1 ate3 meter	RO	kWh	64 bit double
1162	Imp. active=>T2	Import active Tariff 2 me er	RO	kWh	64 bit double
1166	Exp.active=>T1	Import active Tariff 1 me er	RO	kWh	64 bit double
1170	Exp. active=>T1_1	Export active Tariff 1 ate1 meter	RO	kWh	64 bit double
1174	Exp. active=>T1_2	Export active Tariff 1 ate2 meter	RO	kWh	64 bit double
1178	Exp. active=>T1_3	Export active Tariff 1 ate3 meter	RO	kWh	64 bit double
1182	Exp. active=>T2	Export active Tariff 2 me er	RO	kWh	64 bit double
1186	Reactive R1 => T1	Reactive Region-1 Tariff 1 me er	RO	kVArh	64 bit double
1190	Reactive R1 => T1_1	Reactive Region-1 Tariff 1 ate1 meter	RO	kVArh	64 bit double
1194	Reactive R1 => T1_2	Reactive Region-1 Tariff 1 ate2 meter	RO	kVArh	64 bit double
1198	Reactive R1 => T1_3	Reactive Region-1 Tariff 1 ate3 meter	RO	kVArh	64 bit double
1202	Reactive R1 => T2	Reactive Region-1 Tariff 2 me er	RO	kVArh	64 bit double
1206	Reactive R2 => T1	Reactive Region-2 Tariff 1 me er	RO	kVArh	64 bit double
1210	Reactive R2 => T1_1	Reactive Region-2 Tariff 1 ate1 meter	RO	kVArh	64 bit double
1214	Reactive R2 => T1_2	Reactive Region-2 Tariff 1 ate2 meter	RO	kVArh	64 bit double
1218	Reactive R2 => T1_3	Reactive Region-2 Tariff 1 ate3 meter	RO	kVArh	64 bit double
1222	Reactive R2 => T2	Reactive Region-2 Tariff 2 me er	RO	kVArh	64 bit double
1226	Reactive R3 => T1	Reactive Region-3 Tariff 1 me er	RO	kVArh	64 bit double
1230	Reactive R3 => T1_1	Reactive Region-3 Tariff 1 ate1 meter	RO	kVArh	64 bit double
1234	Reactive R3 => T1_2	Reactive Region-3 Tariff 1 ate2 meter	RO	kVArh	64 bit double
1238	Reactive R3 => T1_3	Reactive Region-3 Tariff 1 ate3 meter	RO	kVArh	64 bit double
1242	Reactive R3 => T2	Reactive Region-3 Tariff 2 me er	RO	kVArh	64 bit double
1246	Reactive R4 => T1	Reactive Region-4 Tariff 1 me er	RO	kVArh	64 bit double
1250	Reactive R4 => T1_1	Reactive Region-4 Tariff 1 ate1 meter	RO	kVArh	64 bit double
1254	Reactive R4 => T1_2	Reactive Region-4 Tariff 1 ate2 meter	RO	kVArh	64 bit double
1258	Reactive R4 => T1_3	Reactive Region-4 Tariff 1 ate3 meter	RO	kVArh	64 bit double
1262	Reactive R4 => T2	Reactive Region-4 Tariff 2 me er	RO	kVArh	64 bit double
DI Flags					
1266	Digital Input Flags	Digital Input Active/Passive Flags	RO	-	32 bit int.
Other Counters					
1268	Run Hour Counter	Run Hour Counter	RO	sa.	32 bit int.
1270	On Hour Counter	On Hour Counter	RO	sa.	32 bit int.
1272	Power Interruption Counter	Power Interruption Counter	RO	-	32 bit int.

Address	Parameter	Description	R/W	Unit	Data Type
1274	Total Run minute counter	Total Run minute counter	RO	dak.	32 bit int.
1276	Total On minute counter	Total On minute counter	RO	dak.	32 bit int.
Phase Energies(Double)					
1278	Phase R Import Active Energy T1	T1 Rate Phase R Import Active Energy	RO	kWh	64 bit double
1282	Phase R Import Active Energy T1_1	T1_1 Rate Phase R Import Active Energy	RO	kWh	64 bit double
1286	Phase R Import Active Energy T1_2	T1_2 Rate Phase R Import Active Energy	RO	kWh	64 bit double
1290	Phase R Import Active Energy T1_3	T1_3 Rate Phase R Import Active Energy	RO	kWh	64 bit double
1294	Phase R Import Active Energy T2	T2 Rate Phase R Import Active Energy	RO	kWh	64 bit double
1298	Phase S Import Active Energy T1	T1_1 Rate Phase S Import Active Energy	RO	kWh	64 bit double
1302	Phase S Import Active Energy T1_1	T1_2 Rate Phase S Import Active Energy	RO	kWh	64 bit double
1306	Phase S Import Active Energy T1_2	T1_2 Rate Phase S Import Active Energy	RO	kWh	64 bit double
1310	Phase S Import Active Energy T1_3	T1_3 Rate Phase S Import Active Energy	RO	kWh	64 bit double
1314	Phase S Import Active Energy T2	T2 Rate Phase S Import Active Energy	RO	kWh	64 bit double
1318	Phase T Import Active Energy T1	T1 Rate Phase T Import Active Energy	RO	kWh	64 bit double
1322	Phase T Import Active Energy T1_1	T1_1 Rate Phase T Import Active Energy	RO	kWh	64 bit double
1326	Phase T Import Active Energy T1_2	T1_2 Rate Phase T Import Active Energy	RO	kWh	64 bit double
1330	Phase T Import Active Energy T1_3	T1_3 Rate Phase T Import Active Energy	RO	kWh	64 bit double
1334	Phase T Import Active Energy T2	T2 Rate Phase T Import Active Energy	RO	kWh	64 bit double
1338	Phase R Export Active Energy T1	T1 Rate Phase R Export Active Energy	RO	kWh	64 bit double
1342	Phase R Export Active Energy T1_1	T1_1 Rate Phase R Export Active Energy	RO	kWh	64 bit double
1346	Phase R Export Active Energy T1_2	T1_2 Rate Phase R Export Active Energy	RO	kWh	64 bit double
1350	Phase R Export Active Energy T1_3	T1_3 Rate Phase R ExportActive Energy	RO	kWh	64 bit double
1354	Phase R Export Active Energy T2	T2 Rate Phase R ExportActive Energy	RO	kWh	64 bit double
1358	Phase S Export Active Energy T1	T1 Rate Phase S Export Active Energy	RO	kWh	64 bit double
1362	Phase S Export Active Energy T1_1	T1_1 Rate Phase S ExportActive Energy	RO	kWh	64 bit double
1366	Phase S Export Active Energy T1_2	T1_2 Rate Phase S Export Active Energy	RO	kWh	64 bit double
1370	Phase S Export Active Energy T1_3	T1_3 Rate Phase S Export Active Energy	RO	kWh	64 bit double
1374	Phase S Export Active Energy T2	T2 Rate Phase S ExportActive Energy	RO	kWh	64 bit double
1378	Phase T Export Active Energy T1	T1 Rate Phase T Export Active Energy	RO	kWh	64 bit double
1382	Phase T Export Active Energy T1_1	T1_1 Rate Phase T Export Active Energy	RO	kWh	64 bit double
1386	Phase T Export Active Energy T1_2	T1_2 Rate Phase T Export Active Energy	RO	kWh	64 bit double
1390	Phase T Export Active Energy T1_3	T1_3 Rate Phase T Export Active Energy	RO	kWh	64 bit double
1394	Phase T Export Active Energy T2	T2 Rate Phase T Export Active Energy	RO	kWh	64 bit double
1398	Phase R Reactive B1 => T1	Phase R Reactive Region-1 Tariff 1 eter	RO	kVAh	64 bit double
1402	Phase R Reactive B1 => T1_1	Phase R Reactive Region-1 Tariff 1 ate1 Meter	RO	kVAh	64 bit double
1406	Phase R Reactive B1 => T1_2	Phase R Reactive Region-1 Tariff 1 ate2 Meter	RO	kVAh	64 bit double
1410	Phase R Reactive B1 => T1_3	Phase R Reactive Region-1 Tariff 1 ate2 Meter	RO	kVAh	64 bit double
1414	Phase R Reactive B1 => T2	Phase R Reactive Region-1 Tariff 2 eter	RO	kVAh	64 bit double
1418	Phase S Reactive B1 => T1	Phase S Reactive Region-1 Tariff 1 eter	RO	kVAh	64 bit double
1422	Phase S Reactive B1 => T1_1	Phase S Reactive Region-1 Tariff 1 ate1 Meter	RO	kVAh	64 bit double
1426	Phase S Reactive B1 => T1_2	Phase S Reactive Region-1 Tariff 1 ate2 Meter	RO	kVAh	64 bit double
1430	Phase S Reactive B1 => T1_3	Phase S Reactive Region-1 Tariff 1 ate2 Meter	RO	kVAh	64 bit double
1434	Phase S Reactive B1 => T2	Phase S Reactive Region-1 Tariff 2 eter	RO	kVAh	64 bit double
1438	Phase T Reactive B1 => T1	Phase T Reactive Region-1 Tariff 1 eter	RO	kVAh	64 bit double
1442	Phase T Reactive B1 => T1_1	Phase T Reactive Region-1 Tariff 1 ate1 Meter	RO	kVAh	64 bit double
1446	Phase T Reactive B1 => T1_2	Phase T Reactive Region-1 Tariff 1 ate2 Meter	RO	kVAh	64 bit double

Address	Parameter	Description	R/W	Unit	Data Type
1450	Phase T Reactive B1 => T1_3	Phase T Reactive Region-1 Tariff 1 ate2 Meter	RO	kVArh	64 bit double
1454	Phase T Reactive B1 => T2	Phase T Reactive Region-1 Tariff 2 eter	RO	kVArh	64 bit double
1458	Phase R Reactive B2 => T1	Phase R Reactive Region-2 Tariff 1 eter	RO	kVArh	64 bit double
1462	Phase R Reactive B2 => T1_1	Phase R Reactive Region-2 Tariff 1 ate1 Meter	RO	kVArh	64 bit double
1466	Phase R Reactive B2 => T1_2	Phase R Reactive Region-2 Tariff 1 ate2 Meter	RO	kVArh	64 bit double
1470	Phase R Reactive B2 => T1_3	Phase R Reactive Region-2 Tariff 1 ate2 Meter	RO	kVArh	64 bit double
1474	Phase R Reactive B2 => T2	Phase R Reactive Region-2 Tariff 2 eter	RO	kVArh	64 bit double
1478	Phase S Reactive B2 => T1	Phase S Reactive Region-2 Tariff 1 eter	RO	kVArh	64 bit double
1482	Phase S Reactive B2 => T1_1	Phase S Reactive Region-2 Tariff 1 ate1 Meter	RO	kVArh	64 bit double
1486	Phase S Reactive B2 => T1_2	Phase S Reactive Region-2 Tariff 1 ate2 Meter	RO	kVArh	64 bit double
1490	Phase S Reactive B2 => T1_3	Phase S Reactive Region-2 Tariff 1 ate2 Meter	RO	kVArh	64 bit double
1494	Phase S Reactive B2 => T2	Phase S Reactive Region-2 Tariff 2 eter	RO	kVArh	64 bit double
1498	Phase T Reactive B2 => T1	Phase T Reactive Region-2 Tariff 1 eter	RO	kVArh	64 bit double
1502	Phase T Reactive B2 => T1_1	Phase T Reactive Region-2 Tariff 1 ate1 Meter	RO	kVArh	64 bit double
1506	Phase T Reactive B2 => T1_2	Phase T Reactive Region-2 Tariff 1 ate2 Meter	RO	kVArh	64 bit double
1510	Phase T Reactive B2 => T1_3	Phase T Reactive Region-2 Tariff 1 ate2 Meter	RO	kVArh	64 bit double
1514	Phase T Reactive B2 => T2	Phase T Reactive Region-2 Tariff 2 eter	RO	kVArh	64 bit double
1518	Phase R Reactive B3 => T1	Phase R Reactive Region-3 Tariff 1 eter	RO	kVArh	64 bit double
1522	Phase R Reactive B3 => T1_1	Phase R Reactive Region-3 Tariff 1 ate1 Meter	RO	kVArh	64 bit double
1526	Phase R Reactive B3 => T1_2	Phase R Reactive Region-3 Tariff 1 ate2 Meter	RO	kVArh	64 bit double
1530	Phase R Reactive B3 => T1_3	Phase R Reactive Region-3 Tariff 1 ate2 Meter	RO	kVArh	64 bit double
1534	Phase R Reactive B3 => T2	Phase R Reactive Region-3 Tariff 2 eter	RO	kVArh	64 bit double
1538	Phase S Reactive B3 => T1	Phase S Reactive Region-3 Tariff 1 eter	RO	kVArh	64 bit double
1542	Phase S Reactive B3 => T1_1	Phase S Reactive Region-3 Tariff 1 ate1 Meter	RO	kVArh	64 bit double
1546	Phase S Reactive B3 => T1_2	Phase S Reactive Region-3 Tariff 1 ate2 Meter	RO	kVArh	64 bit double
1550	Phase S Reactive B3 => T1_3	Phase S Reactive Region-3 Tariff 1 ate2 Meter	RO	kVArh	64 bit double
1554	Phase S Reactive B3 => T2	Phase S Reactive Region-3 Tariff 2 eter	RO	kVArh	64 bit double
1558	Phase T Reactive B3 => T1	Phase T Reactive Region-3 Tariff 1 eter	RO	kVArh	64 bit double
1562	Phase T Reactive B3 => T1_1	Phase T Reactive Region-3 Tariff 1 ate1 Meter	RO	kVArh	64 bit double
1566	Phase T Reactive B3 => T1_2	Phase T Reactive Region-3 Tariff 1 ate2 Meter	RO	kVArh	64 bit double
1570	Phase T Reactive B3 => T1_3	Phase T Reactive Region-3 Tariff 1 ate2 Meter	RO	kVArh	64 bit double
1574	Phase T Reactive B3 => T2	Phase T Reactive Region-3 Tariff 2 eter	RO	kVArh	64 bit double
1578	Phase R Reactive B4 => T1	Phase R Reactive Region-4 Tariff 1 eter	RO	kVArh	64 bit double
1582	Phase R Reactive B4 => T1_1	Phase R Reactive Region-4 Tariff 1 ate1 Meter	RO	kVArh	64 bit double
1586	Phase R Reactive B4 => T1_2	Phase R Reactive Region-4 Tariff 1 ate2 Meter	RO	kVArh	64 bit double
1590	Phase R Reactive B4 => T1_3	Phase R Reactive Region-4 Tariff 1 ate2 Meter	RO	kVArh	64 bit double
1594	Phase R Reactive B4 => T2	Phase R Reactive Region-4 Tariff 2 eter	RO	kVArh	64 bit double
1598	Phase S Reactive B4 => T1	Phase S Reactive Region-4 Tariff 1 eter	RO	kVArh	64 bit double
1602	Phase S Reactive B4 => T1_1	Phase S Reactive Region-4 Tariff 1 ate1 Meter	RO	kVArh	64 bit double
1606	Phase S Reactive B4 => T1_2	Phase S Reactive Region-4 Tariff 1 ate2 Meter	RO	kVArh	64 bit double
1610	Phase S Reactive B4 => T1_3	Phase S Reactive Region-4 Tariff 1 ate2 Meter	RO	kVArh	64 bit double
1614	Phase S Reactive B4 => T2	Phase S Reactive Region-4 Tariff 2 eter	RO	kVArh	64 bit double
1618	Phase T Reactive B4 => T1	Phase T Reactive Region-4 Tariff 1 eter	RO	kVArh	64 bit double
1622	Phase T Reactive B4 => T1_1	Phase T Reactive Region-4 Tariff 1 ate1 Meter	RO	kVArh	64 bit double
1626	Phase T Reactive B4 => T1_2	Phase T Reactive Region-4 Tariff 1 ate2 Meter	RO	kVArh	64 bit double
1630	Phase T Reactive B4 => T1_3	Phase T Reactive Region-4 Tariff 1 ate2 Meter	RO	kVArh	64 bit double

Address	Parameter	Description	R/W	Unit	Data Type
1634	Phase T Reactive B4 => T2	Phase T Reactive Region-4 Tariff 2 eter	RO	kVArh	32 bit time_t (unix time)
Digital Output Logs					
1638	Log 1 Time stamp	Log 1 Time stamp	RO	-	32 bit time_t (unix time)
1640	Log 1 Data	Log 1 Data	RO	-	32 bit integer
1642	Log 2 Time stamp	Log 2 Time stamp	RO	-	32 bit time_t (unix time)
1644	Log 2 Data	Log 2 Data	RO	-	32 bit integer
1646	Log 3 Time stamp	Log 3 Time stamp	RO	-	32 bit time_t (unix time)
1648	Log 3 Data	Log 3 Data	RO	-	32 bit integer
1650	Log 4 Time stamp	Log 4 Time stamp	RO	-	32 bit time_t (unix time)
1652	Log 4 Data	Log 4 Data	RO	-	32 bit integer
1654	Log 5 Time stamp	Log 5 Time stamp	RO	-	32 bit time_t (unix time)
1656	Log 5 Data	Log 5 Data	RO	-	32 bit integer
1658	Log 6 Time stamp	Log 6 Time stamp	RO	-	32 bit time_t (unix time)
1660	Log 6 Data	Log 6 Data	RO	-	32 bit integer
1662	Log 7 Time stamp	Log 7 Time stamp	RO	-	32 bit time_t (unix time)
1664	Log 7 Data	Log 7 Data	RO	-	32 bit integer
1666	Log 8 Time stamp	Log 8 Time stamp	RO	-	32 bit time_t (unix time)
1668	Log 8 Data	Log 8 Data	RO	-	32 bit integer
1670	Log 9 Time stamp	Log 9 Time stamp	RO	-	32 bit time_t (unix time)
1672	Log 9 Data	Log 9 Data	RO	-	32 bit integer
1674	Log 10 Time stamp	Log 10 Time stamp	RO	-	32 bit time_t (unix time)
1676	Log 10 Data	Log 10 Data	RO	-	32 bit integer
1678	Log 11 Time stamp	Log 11 Time stamp	RO	-	32 bit time_t (unix time)
1680	Log 11 Data	Log 11 Data	RO	-	32 bit integer
1682	Log 12 Time stamp	Log 12 Time stamp	RO	-	32 bit time_t (unix time)
1684	Log 12 Data	Log 12 Data	RO	-	32 bit integer
1686	Log 13 Time stamp	Log 13 Time stamp	RO	-	32 bit time_t (unix time)
1688	Log 13 Data	Log 13 Data	RO	-	32 bit integer
1690	Log 14 Time stamp	Log 14 Time stamp	RO	-	32 bit time_t (unix time)
1692	Log 14 Data	Log 14 Data	RO	-	32 bit integer
1694	Log 15 Time stamp	Log 15 Time stamp	RO	-	32 bit time_t (unix time)
1696	Log 15 Data	Log 15 Data	RO	-	32 bit integer
1698	Log 16 Time stamp	Log 16 Time stamp	RO	-	32 bit time_t (unix time)
1700	Log 16 Data	Log 16 Data	RO	-	32 bit integer
1702	Log 17 Time stamp	Log 17 Time stamp	RO	-	32 bit time_t (unix time)
1704	Log 17 Data	Log 17 Data	RO	-	32 bit integer
1706	Log 18 Time stamp	Log 18 Time stamp	RO	-	32 bit time_t (unix time)
1708	Log 18 Data	Log 18 Data	RO	-	32 bit integer
1710	Log 19 Time stamp	Log 19 Time stamp	RO	-	32 bit time_t (unix time)
1712	Log 19 Data	Log 19 Data	RO	-	32 bit integer
1714	Log 20 Time stamp	Log 20 Time stamp	RO	-	32 bit time_t (unix time)
1716	Log 20 Data	Log 20 Data	RO	-	32 bit integer
1718	Log 21 Time stamp	Log 21 Time stamp	RO	-	32 bit time_t (unix time)
1720	Log 21 Data	Log 21 Data	RO	-	32 bit integer
1722	Log 22 Time stamp	Log 22 Time stamp	RO	-	32 bit time_t (unix time)

Address	Parameter	Description	R/W	Unit	Data Type
1724	Log 22 Data	Log 22 Data	RO	-	32 bit integer
1726	Log 23 Time stamp	Log 23 Time stamp	RO	-	32 bit time_t (unix time)
1728	Log 23 Data	Log 23 Data	RO	-	32 bit integer
1730	Log 24 Time stamp	Log 24 Time stamp	RO	-	32 bit time_t (unix time)
1732	Log 24 Data	Log 24 Data	RO	-	32 bit integer
1734	Log 25 Time stamp	Log 25 Time stamp	RO	-	32 bit time_t (unix time)
1736	Log 25 Data	Log 25 Data	RO	-	32 bit integer
1738	Log 26 Time stamp	Log 26 Time stamp	RO	-	32 bit time_t (unix time)
1740	Log 26 Data	Log 26 Data	RO	-	32 bit integer
1742	Log 27 Time stamp	Log 27 Time stamp	RO	-	32 bit time_t (unix time)
1744	Log 27 Data	Log 27 Data	RO	-	32 bit integer
1746	Log 28 Time stamp	Log 28 Time stamp	RO	-	32 bit time_t (unix time)
1748	Log 28 Data	Log 28 Data	RO	-	32 bit integer

NOTE:

Tariff meters Index Values can be read in 32 bit and/or 64 bit floating point format. Mathematically, 64 bit floating point representation is more accurate than 32 bit floating point format.

E.g.:

When it is required to read "Tariff 1 Import Active Index" value, it can be received either 32 bit floating point format (registers 404, 405) or in 64 bit floating point format (registers 1366, 1367, 1368, 1369)

Unix time:

Unix time is the number of seconds elapsed since midnight (00:00) Coordinated Universal Time (UTC) of January 1, 1970, not counting leap seconds.

4.5.1.1 Alarm Flags

Each bit of an alarm flag variable corresponds to 'one' alarm flag.

If any bit's value is "1", then there is alarm for that bit. On the contrary, a bit value of "0" means that there is NO alarm for that bit.

The contents of alarm flag variables are listed below.

Alarms 1							
b7 THDV1	b6 I3	b5 I2	b4 I2	b3 V3	b2 V2	b1 V1	b0 Sic.
b15 VLL2	b14 VLL1	b13 -	b12 V3 Harmonics	b11 V2 Harmonics	b10 V1 Harmonics	b9 THDV3	b8 THDV2
b23 Q3	b22 Q2	b21 Q1	b20 P3	b19 P2	b18 P1	b17 IN	b16 VLL3
b31 PF2	b30 PF1	b29 CosØ3	b28 CosØ2	b27 CosØ1	b26 S3	b25 S2	b24 S1
Alarms 2							
b7 I1 Harmonics	b6 THDI3	b5 THDI2	b4 THDI1	b3 F3	b2 F2	b1 F1	b0 PF3
b15 -	b14 -	b13 -	b12 -	b11 Battery Voltage	b10 -	b9 I3 Harmonics	b8 I2 Harmonics
b23 -	b22 -	b21 -	b20 -	b19 -	b18 -	b17 -	b16 -
b31 -	b30 -	b29 -	b28 -	b27 -	b26 -	b25 -	b24 -

4.5.1.2 Digital Input Flags

In order to understand related digital input active or passive, user should query 1446th modebus address. If related digital input is active(shorted with GND), the reading value will be "1" otherwise "0".

e.g.

Assume that, 1146th modebus address is being queried;

if bit1 equals 1 => it means, DI2 and GND are short circuit in that moment. if bit1 equals 0 => it means, DI2 and GND are open circuit in that moment.

DI Bayrakları							
bit 31 -	bit 30 -	bit 29 -	bit 28 -	bit 27 -	bit 26 -	bit 25 -	bit 24 -
bit 23 -	bit 22 -	bit 21 -	bit 20 -	bit 19 -	bit 18 -	bit 17 -	bit 16 -
bit 15 -	bit 14 -	bit 13 -	bit 12 -	bit 11 -	bit 10 -	bit 9 -	bit 8 -
bit 7 -	bit 6 -	bit 5 -	bit 4 -	bit 3 -	bit 2 -	bit 1 D12	bit 0 D11

Abbreviations used for the Alarm Flags are:

Temp.	: Temperature
V1	: Phase1 (L-N) Voltage
V2	: Phase2 (L-N) Voltage
V3	: Phase3 (L-N) Voltage
I1	: Phase1 Current
I2	: Phase2 Current
I3	: Phase3 Current
THDV1	: Phase1 Total Harmonic Distortion in Voltage
THDV2	: Phase2 Total Harmonic Distortion in Voltage
THDV3	: Phase3 Total Harmonic Distortion in Voltage
V1 Harmonics	: Phase1 Voltage Harmonics
V2 Harmonics	: Phase2 Voltage Harmonics
V3 Harmonics	: Phase3 Voltage Harmonics
VLL1	: Phase1-Phase2 Voltage
VLL2	: Phase2-Phase3 Voltage
VLL3	: Phase3-Phase1 Voltage
IN	: Neutral Current
P1	: Phase1 Active Power
P2	: Phase2 Active Power
P3	: Phase3 Active Power
Q1	: Phase1 Reactive Power
Q2	: Phase2 Reactive Power
Q3	: Phase3 Reactive Power
S1	: Phase1 Apparent Power
S2	: Phase2 Apparent Power
S3	: Phase3 Apparent Power
CosØ1	: Phase1 CosØ
CosØ2	: Phase2 CosØ
CosØ3	: Phase3 CosØ
PF1	: Phase1 Power Factor
PF2	: Phase2 Power Factor
PF3	: Phase3 Power Factor
F1	: Phase1 Frequency
F2	: Phase2 Frequency
F3	: Phase3 Frequency
THDI1	: Phase1 Total Harmonic Distortion in Current
THDI2	: Phase2 Total Harmonic Distortion in Current
THDI3	: Phase3 Total Harmonic Distortion in Current
I1 Harmonics	: Phase1 Current Harmonics
I2 Harmonics	: Phase2 Current Harmonics
I3 Harmonics	: Phase3 Current Harmonics

4.5.2 KLEA Setting Parameters

Operator/programmer should use '10H - Write Multiple Registers and '06H - Write Single Register' to change settings parameters.

Operator/programmer should use '0x3H - Read Holding Registers' function to read setting parameters.

1 register -> comprises of 2 bytes.



After Klea setting parameters have been changed, in order for the new values to be saved in non-volatile memory; 0x0000 should be written to register 1998, and 0x0001 should be written in register 1999, within 60 seconds following the last setting change. Only after that, changes will be stored in the permanent memory.

NOTE1:

3 parameters given with "RO (Read Only)" in Table 4-5 are read-only data. They cannot be changed by the user. This data is as given below:

- Serial Number
- Firmware Version
- Compiler Version

NOTE2:

1998 addressed variable at the end of Table 4-5 is a "W (only writable)" variable.

Tablo 4-5 Setting Parameters

Address	Parameter	Data Type	Descript.	R/W	Unit	Low Limit	High Limit
Network Settings							
2000	Current Transf. Ratio (CTR)	32 bit flo t	-	R/W	-	1	5000
2002	Voltage Transf. Ratio (VTR)	32 bit flo t	-	R/W	-	1	5000
2004	Connection	32 bit flo t	SL1	R/W	-	0	2
2006	Demand Period	32 bit flo t	-	R/W	dakika	1	60
2008	Power Unit	32 bit flo t	SL2	R/W	-	0	1
Energy Settings							
2010	T1_1 Start Time	32 bit int.	-	R/W	hour	0	23
2012	T1_2 Start Time	32 bit int.	-	R/W	hour	0	23
2014	T1_3 Start Time	32 bit int.	-	R/W	hour	0	23

Address	Parameter	Data Type	Descript.	R/W	Unit	Low Limit	High Limit
2016	Start of day	32 bit int.	-	R/W	hour	0	23
2018	Start of month	32 bit int.	-	R/W	-	1	28
2020	T1 kWh	32 bit flo t	-	R/W	KWh	0	20000000000.0
2022	T1 kWh E.	32 bit flo t	-	R/W	KWh	0	20000000000.0
2024	T1.KVArh I Imp.	32 bit flo t	-	R/W	KVArh	0	20000000000.0
2026	T1.KVArh C Imp.	32 bit flo t	-	R/W	KVArh	0	20000000000.0
2028	T1.KVArh I Exp.	32 bit flo t		R/W	KVArh	0	20000000000.0
2030	T1.KVArh C Exp.	32 bit flo t		R/W	KVArh	0	20000000000.0
2032	T1_1.KWh	32 bit flo t	-	R/W	KWh	0	20000000000.0
2034	T1_1.KWhE	32 bit flo t	-	R/W	KWh	0	20000000000.0
2036	T1_1.KVArh I Imp.	32 bit flo t	-	R/W	KVArh	0	20000000000.0
2038	T1_1.KVArh C Imp.	32 bit flo t	-	R/W	KVArh	0	20000000000.0
2040	T1_1.KVArh I Exp.	32 bit flo t		R/W	KVArh	0	20000000000.0
2042	T1_1.KVArh C Exp.	32 bit flo t		R/W	KVArh	0	20000000000.0
2044	T1_2.KWh	32 bit flo t	-	R/W	KWh	0	20000000000.0
2046	T1_2.KWhE	32 bit flo t	-	R/W	KWh	0	20000000000.0
2048	T1_2.KVArh I Imp.	32 bit flo t	-	R/W	KVArh	0	20000000000.0
2050	T1_2.KVArh C Imp.	32 bit flo t	-	R/W	KVArh	0	20000000000.0
2052	T1_2.KVArh I Exp.	32 bit flo t		R/W	KVArh	0	20000000000.0
2054	T1_2.KVArh C Exp.	32 bit flo t		R/W	KVArh	0	20000000000.0
2056	T1_3.KWh	32 bit flo t	-	R/W	KWh	0	20000000000.0
2058	T1_3.KWhE	32 bit flo t	-	R/W	KWh	0	20000000000.0
2060	T1_3.KVArh I Imp.	32 bit flo t	-	R/W	KVArh	0	20000000000.0
2062	T1_3.KVArh C Imp.	32 bit flo t	-	R/W	KVArh	0	20000000000.0
2064	T1_3.KVArh I Exp.	32 bit flo t		R/W	KVArh	0	20000000000.0
2066	T1_3.KVArh C Exp.	32 bit flo t		R/W	KVArh	0	20000000000.0
2068	T2.KWh	32 bit flo t	-	R/W	KWh	0	20000000000.0
2070	T2.KWhE	32 bit flo t	-	R/W	KWh	0	20000000000.0
2072	T2.KVArh I Imp.	32 bit flo t	-	R/W	KVArh	0	20000000000.0
2074	T2.KVArh C Imp.	32 bit flo t	-	R/W	KVArh	0	20000000000.0
2076	T2.KVArh I Exp.	32 bit flo t		R/W	KVArh	0	20000000000.0
2078	T2.KVArh C Exp.	32 bit flo t		R/W	KVArh	0	20000000000.0
Digital Output Settings							
2080	Output 1 Mode	32 bit int.	SL3	R/W	-	0	13
2082	Output 1 Energy	32 bit flo t	-	R/W	-	0,001	10000000000
2084	Output 1 Width	32 bit int.	-	R/W	msn	50	2500
2086	Output 1 Multiplier	32 bit int.	-	R/W	-	1	10000
2088	Output 2 Mode	32 bit int.	SL3	R/W	-	0	13
2090	Output 2 Energy	32 bit flo t	-	R/W	-	0,001	10000000000
2092	Output 2 Width	32 bit int.	-	R/W	msn	50	2500
2094	Output 2 Multiplier	32 bit int.	-	R/W	-	1	10000
Digital Input Setting							
2096	Input 1 Mode	32 bit int.	SL4	R/W	-	0	2
2098	Input 1 Delay	32 bit int.	-	R/W	msn	10	2000
2100	Input 2 Mode	32 bit int.	SL4	R/W	-	0	2

Address	Parameter	Data Type	Descript.	R/W	Unit	Low Limit	High Limit
2102	Input 2 Delay	32 bit int.	-	R/W	msn	10	2000
Communication Settings							
2104	Baud Rate	32 bit int.	SL5	R/W	-	0	6
2106	Slave ID	32 bit int.	-	R/W	-	1	247
Alarms							
Gerilim (L-N) Alarmı							
2108	Alarm Relay	32 bit int.	SL6	R/W	-	0	2
2110	Low Limit	32 bit flo t	-	R/W	V	0	1500000
2112	High Limit	32 bit flo t	-	R/W	V	0	1500000
2114	Delay	32 bit int.	-	R/W	sn	0	600
2116	Hysteresis	32 bit flo t	-	R/W	%	0	20
Voltage (L-L) Alarm							
2118	Alarm Relay	32 bit int.	SL6	R/W	-	0	2
2120	Low Limit	32 bit flo t	-	R/W	V	0	2600000
2122	High Limit	32 bit flo t	-	R/W	V	0	2600000
2124	Delay	32 bit int.	-	R/W	sn	0	600
2126	Hysteresis	32 bit flo t	-	R/W	%	0	20
Current Alarm							
2128	Alarm Relay	32 bit int.	SL6	R/W	-	0	2
2130	Low Limit	32 bit flo t	-	R/W	A	0	30000
2132	High Limit	32 bit flo t	-	R/W	A	0	30000
2134	Delay	32 bit int.	-	R/W	sn	0	600
2136	Hysteresis	32 bit flo t	-	R/W	%	0	20
Active Power Alarm							
2138	Alarm Relay	32 bit int.	SL6	R/W	-	0	2
2140	Low Limit	32 bit flo t	-	R/W	W	-1,00E+10	1,00E+10
2142	High Limit	32 bit flo t	-	R/W	W	-1,00E+10	1,00E+10
2144	Delay	32 bit int.	-	R/W	sn	0	600
2146	Hysteresis	32 bit flo t	-	R/W	%	0	20
Reactive Power Alarm							
2148	Alarm Relay	32 bit int.	SL6	R/W	-	0	2
2150	Low Limit	32 bit flo t	-	R/W	VAr	-1,00E+10	1,00E+10
2152	High Limit	32 bit flo t	-	R/W	VAr	-1,00E+10	1,00E+10
2154	Delay	32 bit int.	-	R/W	sn	0	600
2156	Hysteresis	32 bit flo t	-	R/W	%	0	20
Apparent Power Alarm							
2158	Alarm Relay	32 bit int.	SL6	R/W	-	0	2
2160	Low Limit	32 bit flo t	-	R/W	VA	0	1,00E+10
2162	High Limit	32 bit flo t	-	R/W	VA	0	1,00E+10
2164	Delay	32 bit int.	-	R/W	sn	0	600
2166	Hysteresis	32 bit flo t	-	R/W	%	0	20
Neutral Current Alarm							
2168	Alarm Relay	32 bit int.	SL6	R/W	-	0	2
2170	Low Limit	32 bit flo t	-	R/W	A	0	30000
2172	High Limit	32 bit flo t	-	R/W	A	0	30000

Address	Parameter	Data Type	Descript.	R/W	Unit	Low Limit	High Limit
2174	Delay	32 bit int.	-	R/W	sn	0	600
2176	Hysteresis	32 bit flo t	-	R/W	%	0	20
Power Factor Alarm							
2178	Alarm Relay	32 bit int.	SL6	R/W	-	0	2
2180	Low Limit	32 bit flo t	-	R/W	-	0	1
2182	High Limit	32 bit flo t	-	R/W	-	0	1
2184	Delay	32 bit int.	-	R/W	sn	0	600
2186	Hysteresis	32 bit flo t	-	R/W	%	0	20
CosØ Alarm							
2188	Alarm Relay	32 bit int.	SL6	R/W	-	0	2
2190	Low Limit	32 bit flo t	-	R/W	-	0	1
2192	High Limit	32 bit flo t	-	R/W	-	0	1
2194	Delay	32 bit int.	-	R/W	sn	0	600
2196	Hysteresis	32 bit flo t	-	R/W	%	0	20
Frequency Alarm							
2198	Alarm Relay	32 bit int.	SL6	R/W	-	0	2
2200	Low Limit	32 bit flo t	-	R/W	Hz	35	70
2202	High Limit	32 bit flo t	-	R/W	Hz	35	70
2204	Delay	32 bit int.	-	R/W	sn	0	600
2206	Hysteresis	32 bit flo t	-	R/W	%	0	20
Temperature Alarm							
2208	Alarm Relay	32 bit int.	SL6	R/W	-	0	2
2210	Low Limit	32 bit flo t	-	R/W	°C	-20	80
2212	High Limit	32 bit flo t	-	R/W	°C	-20	80
2214	Delay	32 bit int.	-	R/W	sn	0	600
2216	Hysteresis	32 bit flo t	-	R/W	%	0	20
Voltage Harmonics Alarm							
2218	Alarm Relay	32 bit int.	SL6	R/W	-	0	2
2220	THDV High Limit	32 bit flo t	-	R/W	%	0	100
2222	V3 High Limit	32 bit flo t	-	R/W	%	0	100
2224	V5 High Limit	32 bit flo t	-	R/W	%	0	100
2226	V7 High Limit	32 bit flo t	-	R/W	%	0	100
2228	V9 High Limit	32 bit flo t	-	R/W	%	0	100
2230	V11 High Limit	32 bit flo t	-	R/W	%	0	100
2232	V13 High Limit	32 bit flo t	-	R/W	%	0	100
2234	V15 High Limit	32 bit flo t	-	R/W	%	0	100
2236	V17 High Limit	32 bit flo t	-	R/W	%	0	100
2238	V19 High Limit	32 bit flo t	-	R/W	%	0	100
2240	V21 High Limit	32 bit flo t	-	R/W	%	0	100
2242	Delay	32 bit int.	-	R/W	sn	0	600
Current Harmonics Alarm							
2244	Alarm Relay	32 bit int.	SL6	R/W	-	0	2
2246	THDV High Limit	32 bit flo t	-	R/W	%	0	100
2248	I3 High Limit	32 bit flo t	-	R/W	%	0	100
2250	I5 High Limit	32 bit flo t	-	R/W	%	0	100

Address	Parameter	Data Type	Descript.	R/W	Unit	Low Limit	High Limit
2252	I7 High Limit	32 bit flo t	-	R/W	%	0	100
2254	I9 High Limit	32 bit flo t	-	R/W	%	0	100
2256	I11 High Limit	32 bit flo t	-	R/W	%	0	100
2258	I13 High Limit	32 bit flo t	-	R/W	%	0	100
2260	I15 High Limit	32 bit flo t	-	R/W	%	0	100
2262	I17 High Limit	32 bit flo t	-	R/W	%	0	100
2264	I19 High Limit	32 bit flo t	-	R/W	%	0	100
2266	I21 High Limit	32 bit flo t	-	R/W	%	0	100
2268	Delay	32 bit int.	-	R/W	sn	0	600
Device Settings							
2270	Language	32 bit int.	SL7	R/W	-	0	1
2272	Contrast	32 bit int.	SL8	R/W	-	0	8
2274	Password	32 bit int.	-	R/W	-	1	999
2276	Display on	32 bit int.	SL9	R/W	-	0	1
2278	Display on Time	32 bit int.	-	R/W	sn	10	600
2280	Serial Number	32 bit int.	-	RO	-	0	0
2282	Firmware Version	32 bit flo t	-	RO	-	0	0
2284	Order Number	32 bit flo t	-	RO	-	0	0
2286	Config Name	String	-	R/W	-	0	0
2298	Device Name	String	-	R/W	-	0	0
Digital Output Settings(Optional*)							
2310	Output3 Mode	32 bit int.	SL3	R/W	-	0	13
2312	Output3 Energy	32 bit flo t	-	R/W	-	0,001	10000000000
2314	Output3 Width	32 bit int.	-	R/W	msn	50	2500
2316	Output3 Multiplier	32 bit int.	-	R/W	-	1	10000
2318	Output4 Mode	32 bit int.	SL3	R/W	-	0	13
2320	Output4 Energy	32 bit flo t	-	R/W	-	0,001	10000000000
2322	Output4 Width	32 bit int.	-	R/W	msn	50	2500
2324	Output4 Mode	32 bit int.	-	R/W	-	1	10000
2326	Output5 Connection	32 bit int.	SL3	R/W	-	0	13
2328	Output5 Energy	32 bit flo t	-	R/W	-	0,001	10000000000
2330	Output5 Width	32 bit int.	-	R/W	msn	50	2500
2332	Output5 Multiplier	32 bit int.	-	R/W	-	1	10000
2334	Output6 Mode	32 bit int.	SL3	R/W	-	0	13
2336	Output6 Energy	32 bit flo t	-	R/W	-	0,001	10000000000
2338	Output6 Width	32 bit int.	-	R/W	msn	50	2500
2340	Output6 Multiplier	32 bit int.	-	R/W	-	1	10000
2342	Output7 Mode	32 bit int.	SL3	R/W	-	0	13
2344	Output7 Energy	32 bit flo t	-	R/W	-	0,001	10000000000
2346	Output7 Width	32 bit int.	-	R/W	msn	50	2500
2348	Output7 Multiplier	32 bit int.	-	R/W	-	1	10000
Digital Input Settings (Optional*)							
2350	Input3 Mode	32 bit int.	SL4	R/W	-	0	2
2352	Input3 Delay	32 bit flo t	-	R/W	msn	10	2000
2354	Input4 Mode	32 bit int.	SL4	R/W	-	0	2
2356	Input4 Delay	32 bit int.	-	R/W	msn	10	2000

Address	Parameter	Data Type	Descript.	R/W	Unit	Low Limit	High Limit
2358	Input5 Mode	32 bit int.	SL4	R/W	-	0	2
2360	Input5 Delay	32 bit flo t	-	R/W	msn	10	2000
2362	Input6 Mode	32 bit int.	SL4	R/W	-	0	2
2364	Input6 Delay	32 bit int.	-	R/W	msn	10	2000
2366	Input7 Mode	32 bit int.	SL4	R/W	-	0	2
2368	Input7 Delay	32 bit flo t	-	R/W	msn	10	2000
Analog Output Settings (Optional**)							
2370	AO1 Input Mode	32 bit int.	SL10	R/W	-	0	24
2372	AO1 Output Conn.	32 bit int.	SL11	R/W	-	0	5
2374	AO1 Max. Value	32 bit flo t	-	R/W	-	-100000	100000
2376	AO1 Min. Value	32 bit flo t	-	R/W	-	-100000	100000
2378	AO1 Multiplier	32 bit int.	SL12	R/W	-	0	2
2380	AO2 Input Mode	32 bit int.	SL10	R/W	-	0	24
2382	AO2 Output Conn.	32 bit int.	SL11	R/W	-	0	5
2384	AO2 Max. Value	32 bit flo t	-	R/W	-	-100000	100000
2386	AO2 Min. Value	32 bit flo t	-	R/W	-	-100000	100000
2388	AO2 Multiplier	32 bit int.	SL12	R/W	-	0	2
2390	AO3 Input Mode	32 bit int.	SL10	R/W	-	0	24
2392	AO3 Output Conn.	32 bit int.	SL11	R/W	-	0	5
2394	AO3 Max. Value	32 bit flo t	-	R/W	-	-100000	100000
2396	AO3 Min. Value	32 bit flo t	-	R/W	-	-100000	100000
2398	AO3 Multiplier	32 bit int.	SL12	R/W	-	0	2
2400	AO4 Input Mode	32 bit int.	SL10	R/W	-	0	24
2402	AO4 Output Conn.	32 bit int.	SL11	R/W	-	0	5
2404	AO4 Max. Value	32 bit flo t	-	R/W	-	-100000	100000
2406	AO4 Min. Value	32 bit flo t	-	R/W	-	-100000	100000
2408	AO4 Multiplier	32 bit int.	SL12	R/W	-	0	2
2410	Password Activation		-	R/W	-	0	1
Save changes to permanent memory (Write "1")							
1998		32 bit int.	-	W			

*Valid for devices with DIO

** Valdi devices with optional AO

Tablo 4-6 Description List

A1	A2	A3	A4	A5	A6
0-3phase 4wire 1-3phase 3wire 2-Aron	0-Mega 1-Kilo	0-Off 1-T1 kWh 2-T1 kWh E 3T1 -kVArh I. Ind. 4-T1 kVArh I. Cap. 5-T1 kVArh E. Ind. 6-T1 kVArh E. Cap. 7-T2 kWh 8-T2 kWh E. 9-T2 kVArh I. Ind. 10-T2 kVArh I. Cap. 11-T2 kVArh E. Ind. 12-T2 kVArh E. Cap. 13-T2 Digital Input	0-Off 1-2nd tariff 2-Accumulator 3-Run hour	0-2400 1-4800 2-9600 3-19200 4-38400 5-57600 6-115200	0-Off 1-Relay1 2-Relay2

A7	A8	A9	A10	A11	A12
0-Türkçe 1-English 2-Russian	0-Level -4 1-Level -3 2-Level -2 3-Level -1 4-Level 0 5-Level 1 6-Level 2 7-Level 3 8-Level 4	0-Continuous 1-Time Dependent	0- V1 (L-N) 1-V2 (L-N) 2-V3 (L-N) 3-I1 4-I2 5-I3 6-P1 7-P2 8-P3 9-Q1 10-Q2 11-Q3 12-S1 13-S2 14-S3 15-F 16-IN 17-V12 18-V23 19-V31 20-I top. 21-P top. 22-Q top. 23-S top.	0-(0 - 5V) 1-(0 - 10V) 2-(-5 - 5V) 3-(-10 - 10V) 4-(0 - 20mA) 5-(4 - 20mA)	0-1 1-Kilo 2-Mega

E.g.:

If slave ID is assigned as 157;

Request	
Slave ID	01h
Function code	10h
Starting address (high)	08h
Starting address (Low)	26h
Number of registers (high)	00h
Number of registers (Low)	02h
Number of bytes	04h
Register value (high)	00h
Register value (Low)	00h
Register value (high)	00h
Register value (Low)	9Dh
CRC(high)	D7h
CRC(Low)	F4h

KLEA Response	
Slave ID	01h
Function code	10h
Starting address (high)	08h
Starting address (Low)	26h
Number of registers (high)	00h
Number of registers (Low)	02h
CRC(high)	A2h
CRC(Low)	63h

4.5.3 ARCHIVE (HISTORY) RECORDS

Archive records consist of blocks having 68 parameters. Each parameter inside the archive block is a 32 bit length variable. Archive data block is as shown in [Table 4-7](#).

The programmer will access archive by implementing “0x14 - Read File Record” function. “0x14 - Read File Record” function accesses the data with “file numbers”.

For Klea,

File numbers 1 – 1920 are used to access HOURLY data. File numbers 5001- 5240 are used to access DAILY data. File numbers 10001-10036 are used to access MONTHLY data.

- The last saved file number in the hourly data memory; can be accessed from 1360 Modbus addressed parameter ([Table 4-4](#))
- The last saved file number in the daily data memory; can be accessed from 1362 Modbus addressed parameter ([Table 4-4](#))
- The last saved file number in the monthly data memory; can be accessed from 1364 Modbus addressed parameter ([Table 4-4](#))

Tablo 4-7 Archive (History) Record Table

Item No.	History Records	Variable Type
1	Time Info (Timestamp)	32 bit int.
2	L1 average voltage value (V ave.)	32 bit flo t
3	L1 minimum voltage value (V1 min.)	32 bit flo t
4	L1 maximum voltage value (V1 max.)	32 bit flo t
5	L1 average current value (I1 ave.)	32 bit flo t
6	L1 minimum current value (I1 min.)	32 bit flo t
7	L1 maximum current value (I1 max.)	32 bit flo t
8	L1 average active power value (P1 ave.)	32 bit flo t
9	L1 minimum active power value (P1 min.)	32 bit flo t
10	L1 maximum active power value (P1 max.)	32 bit flo t
11	L1 average reactive power value (Q1 ave.)	32 bit flo t
12	L1 minimum reactive power value (Q1 min.)	32 bit flo t
13	L1 maximum reactive power value (Q1 max..)	32 bit flo t
14	L1 average apparent power value (S1 ave.)	32 bit flo t
15	L1 minimum apparent power value (S1 min.)	32 bit flo t
16	L1 maximum apparent power value (S1 max.)	32 bit flo t
17	L1 average cosØ value (cosØ1 ave.)	32 bit flo t
18	L1 average PF value (PF1 ave.)	32 bit flo t
19	L2 average voltage value (V2 ave.)	32 bit flo t
20	L2 minimum voltage value(V2 min.)	32 bit flo t
21	L2 maximum voltage value(V2 max.)	32 bit flo t
22	L2 average current value (I2 ave.)	32 bit flo t
23	L2 minimum current value (I2 min.)	32 bit flo t
24	L2 maximum current value (I2 max.)	32 bit flo t
25	L2 average active power value (P2 ave.)	32 bit flo t
26	L2 minimum active power value (P2 min.)	32 bit flo t
27	L2 maximum active power value (P2 max.)	32 bit flo t
28	L2 average reactive power value (Q2 ave.)	32 bit flo t
29	L2 minimum reactive power value (Q2 min.)	32 bit flo t
30	L2 maximum reactive power value (Q2 max..)	32 bit flo t
31	L2 average apparent power value (S2 ave.)	32 bit flo t
32	L2 minimum apparent power value (S2 min.)	32 bit flo t
33	L2 maximum apparent power value (S2 max.)	32 bit flo t
34	L2 average cosØ value (cosØ2 ave.)	32 bit flo t
35	L2 average PF value (PF2 ave.)	32 bit flo t
36	L3 average voltage value (V3 ave.)	32 bit flo t
37	L3 minimum voltage value (V3 min.)	32 bit flo t
38	L3 maximum voltage value (V3 max.)	32 bit flo t
39	L3 average current value (I3 ave.)	32 bit flo t
40	L3 minimum current value (I3 min.)	32 bit flo t
41	L3 maximum current value (I3 max.)	32 bit flo t
42	L3 average active power value (P3 ave.)	32 bit flo t
43	L3 minimum active power value (P3 min.)	32 bit flo t
44	L3 maximum active power value (P3 max.)	32 bit flo t
45	L3 average reactive power value (Q3 ave.)	32 bit flo t

Item No.	History Records	Variable Type
46	L3 minimum reactive power value (Q3 min.)	32 bit flo t
47	L3 maximum reactive power value (Q3 max..)	32 bit flo t
48	L3 average apparent power value (S3 ave.)	32 bit flo t
49	L3 minimum apparent power value (S3 min.)	32 bit flo t
50	L3 maximum apparent power value (S3 max.)	32 bit flo t
51	L3 average cosØ value (cosØ3 ave.)	32 bit flo t
52	L3 average PF value (PF3 ave.)	32 bit flo t
53	V12 voltage average value (V12 ave.)	32 bit flo t
54	V12 voltage minimum value (V12 min.)	32 bit flo t
55	V12 voltage maximum value (V12 max.)	32 bit flo t
56	V23 voltage average value (V23 ave.)	32 bit flo t
57	V23 voltage minimum value (V23 min.)	32 bit flo t
58	V23 voltage maximum value (V23 max.)	32 bit flo t
59	V31 voltage average value (V31 ave.)	32 bit flo t
60	V31 voltage minimum value (V31 min.)	32 bit flo t
61	V31 voltage maximum value (V31 max.)	32 bit flo t
62	L1 average frequency value (F1 ave.)	32 bit flo t
63	L1 minimum frequency value (F1 min.)	32 bit flo t
64	L1 maximum frequency value (F1 max.)	32 bit flo t

4.5.3.1 Hourly Archive Data

The smallest and largest instantaneous values measured during one hour period, are saved as minimum and maximum values. Likewise, average values of measurements, which were taken in one hour period, are saved as average values.

14h function operates with file numbers. File numbers between 1 – 1920 are used for HOURLY data.

Klea has a memory that is reserved for hourly files. It can keep totally 1920 hourly files.

NOTE: All data is deleted when 1920 hourly records are filled. 1921st data will be the first data of the related memory and the file number will be 1.

The 'last saved file number' inside the hourly memory can be accessed from the 32-bit parameter starting from Modbus address 1360 (Refer to Table 4-4).



EXAMPLE:

Assume that a programmer will try to access a Klea with a slave ID number 1. Assume also that the last saved hourly file number of this device is 17. In this case, data request and Klea response will be as follows:

Sorgu	
Slave ID	0x01
Function code	0x14
Byte Counts	0x07
Sub-req. 1 reference type	0x06
Sub-req. 1 file number HI	0x00
Sub-req. 1 file number LO	0x11
Sub-req. 1 starting reg. addr. HI	0x00
Sub-req. 1 starting reg. addr. LO	0x00
Sub-req. 1 register count HI	0x00
Sub-req. 1 register count LO	0x0A
CRC HI	0xB3
CRC LO	0xD4

Klea cevap	
Slave ID	0x01
Function code	0x14
Byte count	0x16
Sub-req. 1 byte count	0x15
Sub-req. 1 reference type	0x06
Timestamp	XXX
Timestamp	XXX
Timestamp	XXX
Timestamp	XXX

CRC HI	XXX
CRC LO	XXX

The parameters and CRC values in above tables, are as they should be. On the other hand, Klea response is given to describe the message structure. As a result, values for variables are not defined.

4.5.3.2 Daily archive data

Recording of daily data changes with start of day ([Refer to 3.2.1.1.3.4](#)) setting.

The smallest and largest instantaneous values measured during one day period, are saved as minimum and maximum values. Likewise, average values of measurements, which were taken in one day period, are saved as average values.

14h function operates with file numbers. File numbers 5001 – 5240 are used for DAILY data.

Klea has a memory that is reserved for daily files. It can keep totally 240 daily files.

NOTE: All data is deleted when 240 daily records are filled. 241st data will be the first data of the related memory and the file number will be 1.

The 'last saved file number' inside the daily memory can be accessed from the 32-bit parameter starting from Modbus address 1362 ([Refer to Table 4-4](#)).

4.5.3.3 Monthly archive data

Recording of daily data changes with start of month ([Refer to 3.2.1.1.3.5](#)) and start of day ([Refer to 3.2.1.1.3.4](#)) settings.

The smallest and largest instantaneous values measured during one month period, are saved as minimum and maximum values. Likewise, average values of measurements, which were taken in one month period, are saved as average values.

14h function operates with file numbers. File numbers 10001 – 10036 are used for MONTHLY data.

Klea has a memory that is reserved for monthly files. It can keep totally 36 monthly files.

NOTE: All data is deleted when 36 monthly records are filled. 37th data will be the first data of the related memory and the file number will be 1.

The 'last saved file number' inside the monthly memory can be accessed from the 32-bit parameter starting from Modbus address 1364 ([Refer to Table 4-4](#)).

4.5.4 Clear

Operator/programmer can erase/zeroize data stored in non-volatile memory via MODBUS commands. Erasable data are as follows:

- energy meters (all Tariff 1 and Tariff 2 meters)
- demand values
- all digital input counters
- all variables mentioned above
- hourly archive records
- daily archive records
- monthly archive records
- alarm records

Tablo 4-8 Clear Address Table

Address	Data Type	Parameters/Records to be Cleared	R/W	Value	Modbus func.
1902	32 bit int.	Energy meters	W	1	10H-06H
1904	32 bit int.	Demand values	W	1	10H-06H
1906	32 bit int.	Digital Input Counters	W	1	10H-06H
1908	32 bit int.	All variables	W	1	10H-06H
1912	32 bit int.	Hourly archive records	W	1	10H-06H
1914	32 bit int.	Daily archive records	W	1	10H-06H
1916	32 bit int.	Monthly archive records	W	1	10H-06H
1918	32 bit int.	Alarm records	W	1	10H-06H
In order to complete to erase/zeroize, programmer should write 1 to the below MODBUS					
1898	32 bit int.	Compare erasing zerozing	w	1	10H-06H



Clear me işlemini gerçekleştirmek için:

Clear incek parametreler ya da kayıtlar ile ilgili adreslere "1" yazıldıktan sonra, 60 saniye içerisinde, 1898 register'ine 0x00 1899 register'ine 0x01 yazılmalıdır.

A decorative graphic consisting of a grid of interconnected circles in orange and dark blue, with some circles having white outlines. The circles are arranged in a pattern that resembles a molecular structure or a network. The circles are of varying sizes and are connected by thin lines, creating a complex, organic shape.

**SECTION 5
FACTORY DEFAULT
SETTINGS**

BÖLÜM 5 FACTORY DEFAULT SETTINGS

Parameter	Default value	Unit	Setting Range
Network Settings			
Current Transf. Ratio (CTR)	1	-	1<=>5000
Voltage Transf. Ratio (VTR)	1.0	-	1<=>5000
Connection	3 phase 4 wire	-	3phase 4wire/3 phase 3wire/Aron
Demand Period	15	min.	1<=>60
Power Unit	Kilo	-	Kilo/Mega
Device Settings			
Language	English	-	Türkçe/English/ Русский
Contrast	Level 0	-	Level 4 Level -4
New Password	1	-	1 9999
Display on	Time dependent	-	Time dependent/Continuous
Display on time	600	sn	10 600
Energy Settings			
T1_1 Start Time	8	-	0<=>23
T1_2 Start Time	16	-	0<=>23
T1_3 Start Time	0	-	0<=>23
Start of day	0	-	0<=>23
Start of month	1	-	0<=>28
T1 kWh	0.0	kWh	0.0<=>2000000000.0
T1 kWh E.	0.0	kWh	0.0<=>2000000000.0
T1 kVArh Imp. I	0.0	kVArh	0.0<=>2000000000.0
T1 kVArh Imp. C.	0.0	kVArh	0.0<=>2000000000.0
T1 kVArh Exp. I	0.0	kVArh	0.0<=>2000000000.0
T1 kVArh Imp. C.	0.0	kVArh	0.0<=>2000000000.0
T1_1 kWh	0.0	kWh	0.0<=>2000000000.0
T1_1 kWh E.	0.0	kWh	0.0<=>2000000000.0
T1_1 kVArh Imp. I	0.0	kVArh	0.0<=>2000000000.0
T1_1 kVArh Imp. C.	0.0	kVArh	0.0<=>2000000000.0
T1_1 kVArh Exp. I	0.0	kVArh	0.0<=>2000000000.0
T1_1 kVArh Imp. C.	0.0	kVArh	0.0<=>2000000000.0
T1_2 kWh	0.0	kWh	0.0<=>2000000000.0
T1_2 kWh E.	0.0	kWh	0.0<=>2000000000.0
T1_2 kVArh Imp. I	0.0	kVArh	0.0<=>2000000000.0
T1_2 kVArh Imp. C.	0.0	kVArh	0.0<=>2000000000.0
T1_2 kVArh Exp. I	0.0	kVArh	0.0<=>2000000000.0
T1_2 kVArh Imp. C.	0.0	kVArh	0.0<=>2000000000.0
T1_3 kWh	0.0	kWh	0.0<=>2000000000.0
T1_3 kWh E.	0.0	kWh	0.0<=>2000000000.0
T1_3 kVArh Imp. I	0.0	kVArh	0.0<=>2000000000.0
T1_3 kVArh Imp. C.	0.0	kVArh	0.0<=>2000000000.0
T1_3 kVArh Exp. I	0.0	kVArh	0.0<=>2000000000.0

Parameter	Default value	Unit	Setting Range
T1_3 kVArh Imp. C.	0.0	kVArh	0.0<=>20000000000.0
T2 kWh	0.0	kWh	0.0<=>20000000000.0
T2 kWh E.	0.0	kWh	0.0<=>20000000000.0
T2 kVArh Imp. I	0.0	kVArh	0.0<=>20000000000.0
T2 kVArh Imp. C.	0.0	kVArh	0.0<=>20000000000.0
T2 kVArh Exp. I	0.0	kVArh	0.0<=>20000000000.0
T2 kVArh Imp. C.	0.0	kVArh	0.0<=>20000000000.0
Digital Output Settings			
Mode (Input1, 2 -- 7)	Off	-	Off/2.ta ife/Sayıcı
Delay (Input1, 2 -- 7)	100	msn	10<=>2000
Digital Output Settings			
Mode (Output 1, 2 -- 7)	Off	-	Refer to 3.2.1.1.5 Digital Output
Energy (Output 1, 2 -- 7)	1	kWh/KVArh	1<=>500000
Width (Output 1, 2 -- 7)	100	msec	50<=>2500
Multiplier (Output 1, 2 -- 7)	1	-	1<=>10000
Analog Output Settings			
Input mode	Refer to 3.2.1.1.6	-	Refer to 3.2.1.1.6
Output conn.	0 – 5V	V/mA	Refer to 3.2.1.1.6
Min. value	0.0	-	Refer to 3.2.1.1.6
Max. value	0.0	-	Refer to 3.2.1.1.6
Multiplier	1	-	1/Kilo/Mega
Communication Settings			
Baud Rate	38400	Bits/sec.	2400/4800/9600/19200/38400/57600/15200
Slave ID	1	-	1<=>247
Alarm Settings			
V (L-N)			
Low limit	0.0	V	0.0<=>1500000.0
High limit	0.0	V	0.0<=>1500000.0
V (L-L)			
Low limit	0.0	V	0.0<=>2600000.0
High limit	0.0	V	0.0<=>2600000.0
Current			
Low limit	0.0	V	0.0<=>30000.0
High limit	0.0	V	0.0<=>30000.0
P			
Low limit	0.0	V	- 10000000000.0<=>10000000000.0
High limit	0.0	V	- 10000000000.0<=>10000000000.0
Q			
Low limit	0.0	V	- 10000000000.0<=>10000000000.0
High limit	0.0	V	- 10000000000.0<=>10000000000.0
S			
Low limit	0.0	V	0.0<=>10000000000.0
High limit	0.0	V	0.0<=>10000000000.0

CosØ			
Low limit	0.0	V	0.000<=>1.000
High limit	0.0	V	0.000<=>1.000
PF			
Low limit	0.0	V	0.000<=>1.000
High limit	0.0	V	0.000<=>1.000
IN			
Low limit	0.0	V	0.0<=>90000.0
High limit	0.0	V	0.0<=>90000.0
F			
Low limit	0.0	V	35.0<=>70.0
High limit	0.0	V	35.0<=>70.0
Harmonics V			
Low limit	0.0	V	0.0<=>100.0
High limit	0.0	V	0.0<=>100.0
Harmonics I			
Low limit	0.0	V	0.0<=>100.0
High limit	0.0	V	0.0<=>100.0
Temp.			
Low limit	0.0	V	-20 80
High limit	0.0	V	-20 80
Alarm Relay and Alarm Time of V(L-N), V(L-L), Current, P, Q, S, CosØ, PF, IN, F, V Harmonics, I Harmonics and Temp. alarms			
Alarm Relay	Off	-	Off/ elay1/Relay2
Alarm Time	0	sn	0<=>600
Alarm süresi (Harmonics V, I için)	60	sn	0<=>600
Hysteresis of V(L-N), V(L-L), Current, P, Q, S, CosØ, PF, IN, F, V Harmonics, I Harmonics and Temp. alarms			
Hysteresis	0.0	%	0.0<=>20.0



**SECTION 6
TECHNICAL
SPECIFICATIONS**

BÖLÜM 6 TECHNICAL SPECIFICATIONS

Supply

Voltage 85..300V AC/DC

Frequency 45..65 Hz

Measurement Inputs

Voltage 1..300 V RMS (L-N)

Current 0.05..6 A RMS

Frequency 45..65 Hz

Measurement Accuracy

Function Symbol	Function	Function Performance Class According to IEC 61557-12	Measuring Range	Other Complementary Characteristics
P	Total active power	0,2(X5 CT) 0,5 (X1 CT)	10 % $I_n \sim I \sim I$ max 0,5 Ind to 0,8 Cap	—
Q _V	Total reactive power	1	5 % $I_n \sim I \sim I$ max 0,25 Ind to 0,25 Cap	—
S _A	Total apparent power	0,2(X5 CT) 0,5 (X1 CT)	10 % $I_n \sim I \sim I$ max 0,5 Ind to 0,8 Cap	—
E _A	Total active energy	0,2(X5 CT) 0,5 (X1 CT)	0 to 49999999999	IEC 62053-22 Class 0.25
E _{rV}	Total reactive energy	2	0 to 49999999999	IEC 62053-2 Class 2
f	Frequency	0,05	45 – 65 Hz	—
I	Phase current	0,2(X5 CT) 0,5 (X1 CT)	20 % $I_n \sim I \sim I$ max	—
I _{Nc}	Neutral current (calculated)	0,5	20 % $I_n \sim I \sim I$ max	—
U	Voltage	0,2	U _{min} ~ U ~ U _{max}	—
PF _A	Power factor	0,5 (X5 CT) 1 (X1 CT1)	0,5 Ind to 0,8 Cap	—
THDV	Total harmonic distortion voltage	1	0 % to 20 %	—
THDI	Total harmonic distortion current	2	0 % to 100 %	—

Relay Outputs

2 pcs,

Max. switching current : 5A

Max. switching voltage : 250 VAC

Max. switching power : 1250 VA

Digital Input/Output (Digital IO)

2 pcs, 5...30V DC, 50mA

Protection: 3750VRMS , Insulation

Analog Output

2 pcs. (2 pcs. analog output optional model) / 4 pcs. (4 pcs. analog output optional model)
0-5V, 0-10V, -5-5V, -10-10V, 0-20mA, 4-20mA

Current Transformer Ratio (CTR)

1..5000 adjustable.

Voltage Transformer Ratio (VTR)

1..5000 adjustable.

Connection Type

3phase 4 wire
3phase 3 wire Aron

Demand Period

1-60 minutes adjustable.

Operating Temperature

-20°C..+70°C

Storage Temperature

-30°C..+80°C

Relative Humidity

Max. 95%, no condensation

Sizes

W96 x H96 x D72

Protection Class

IP40 front IP20 back

Power Consumption

<3VA

